

ROTORS AND TUBES

For Beckman Coulter
Preparative Ultracentrifuges

User's Manual

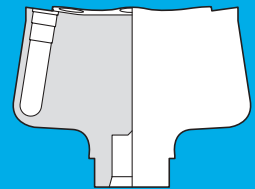

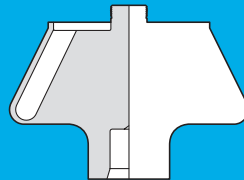
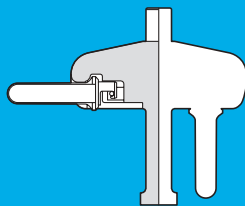
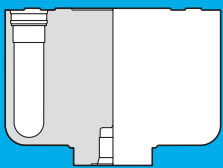

SAFETY NOTICE

This safety notice summarizes information basic to the safe operation of the rotors and accessories described in this manual. The international symbol displayed above is a reminder that all safety instructions should be read and understood before use or maintenance of rotors or accessories. When you see the symbol on other pages, pay special attention to the safety information presented. Also observe any safety information contained in applicable rotor and instrument manuals. Observance of safety precautions will help to avoid actions that could cause personal injury, as well as damage or adversely affect the performance of the instrument/rotor/tube system.

Chemical And Biological Safety

Normal operation may involve the use of solutions and test samples that are pathogenic, toxic, or radioactive. Such materials should not be used in these rotors, however, unless *all necessary safety precautions are taken*.

- Observe all cautionary information printed on the original solution containers prior to their use.
- Handle body fluids with care because they can transmit disease. No known test offers complete assurance that body fluids are free of micro-organisms. Some of the most virulent—Hepatitis (B and C) and HIV (I–V) viruses, atypical mycobacterium, and certain systemic fungi—further emphasize the need for aerosol protection. Handle other infectious samples according to good laboratory procedures and methods to prevent spread of disease. Because spills may generate aerosols, observe proper safety precautions for aerosol containment. Do not run toxic, pathogenic, or radioactive materials in a rotor without taking appropriate safety precautions. Biosafe containment should be used when Risk Group II materials (as identified in the World Health Organization *Laboratory Biosafety Manual*) are handled; materials of a higher group require more than one level of protection.
- Dispose of all waste solutions according to appropriate environmental health and safety guidelines.
- If disassembly reveals evidence of leakage, you should assume that some fluid escaped the rotor. Apply appropriate decontamination procedures to the ultracentrifuge and accessories.

Mechanical Safety

- Use only rotors and accessories designed for use in the ultracentrifuge you are operating. Do not use rotors in ultracentrifuges with any classification except those indicated in the rotor manual or engraved on the rotor.
- Rotors are designed for use at the rated speeds indicated; however, speed reductions may be required because of weight considerations of tubes, adapters, or the density of the solution being centrifuged. Be sure to observe the instructions in the appropriate rotor manual.
- NEVER attempt to slow or stop a rotor by hand.
- Use only components and accessories that have been designed for use in the rotor being centrifuged (refer to the applicable rotor manual). *The safety of rotor components and accessories made by other manufacturers cannot be ascertained by Beckman Coulter. Use of other manufacturers' components or accessories in Beckman Coulter preparative ultracentrifuge rotors may void the rotor warranty and should be prohibited by your laboratory safety officer.*
- The strength of tubes and bottles can vary between lots, and will depend on handling and usage. Pretest in the rotor (using buffer or gradient of equivalent density to the intended sample solution) to determine optimal operating conditions. Scratches (even microscopic ones) significantly weaken glass and polycarbonate tubes.

To help prevent premature failures or hazards by detecting stress corrosion, metal fatigue, wear or damage to anodized coatings, and to instruct laboratory personnel in the proper care of rotors, Beckman Coulter offers the Field Rotor Inspection Program (FRIP). This program involves a visit to your laboratory by a specially trained representative, who will inspect all of your rotors for corrosion or damage. The representative will recommend repair or replacement of at-risk rotors to prevent potential rotor failures. Contact your local Beckman Coulter Sales and Service office to request this service.

It is your responsibility to decontaminate the rotors and accessories before requesting service by Beckman Coulter Field Service.



ROTORS AND TUBES

**For Beckman Coulter
Preparative Ultracentrifuges**

User's Manual

SCOPE OF THIS MANUAL

This manual contains general information for properly preparing a rotor for centrifugation in a Beckman Coulter preparative ultracentrifuge. This manual should be used with the individual rotor instruction manual packed with each rotor. The rotor manuals provide specific information for each rotor, including special operating procedures and precautions; tube, bottle, and adapter part numbers; and equations to calculate maximum allowable rotor speeds. Each manual has a code number in the upper right-hand corner of the cover page that can be used for reordering; send your request (include the code number) to:

Technical Publications Department
Beckman Coulter, Inc.
1050 Page Mill Road
Palo Alto, CA 94304 U.S.A

Telephone (650) 859-1753
Fax (650) 859-1735

A lot of information is compiled in this manual, and we urge you to read it carefully—especially if this is your first experience with Beckman Coulter products.

- In Section 1 you will find descriptions, by usage, of Beckman Coulter's currently produced preparative ultracentrifuge rotors; this should help you determine the appropriate rotor to use for a particular application. Also included in this sections is a discussion of rotor materials, components, and centrifugation techniques.
- Section 2 describes various tubes, bottles, adapters, and spacers to help you choose a particular tube or bottle for your application.
- Section 3 provides instructions for using tubes or bottles and related accessories.
- Section 4 contains step-by-step procedures for preparing a fixed angle rotor for a centrifuge run. Similar information for swinging bucket rotors is in Section 5, and Section 6 contains the same type of information for vertical tube and near-vertical tube rotors. (Analytical, continuous flow, and zonal rotors are not covered in this manual.)
- Section 7 provides rotor, tube, bottle, and accessory care and maintenance information, as well as some diagnostic hints. Please read it. Good rotor care results in longer rotor life.
- Several appendixes contain information that may be of special interest:
 - Appendix A lists chemical resistances for rotor and accessory materials to help determine compatibility with a variety of solutions.
 - Appendix B contains information about the use of the ω^2t integrator.
 - Appendix C describes the use of cesium chloride curves.
 - Appendix D contains reference information on some commonly used gradient materials.
 - Appendix E contains a glossary of terms used in this manual.
 - Appendix F lists references for further reading.

SECTION 1: ROTORS

General Description	1-1
Rotor Designations	1-1
Materials	1-3
Drive Pins	1-3
Rotor Selection	1-4
Pelleting (Differential Separation)	1-8
Isopycnic Separations	1-11
Rate Zonal Separations	1-12
General Operating Information	1-13
Rotor Balance	1-13
Overspeed Protection	1-14
Allowable Run Speeds	1-16

SECTION 2: TUBES, BOTTLES, AND ACCESSORIES

Labware Selection Criteria	2-1
Labware Material Compatibility with Solvents and Sample	2-3
Gradient Formation and Fractionation	2-3
Labware Types	2-3
Polyallomer Tubes	2-4
Polycarbonate Tubes	2-5
Polypropylene Tubes	2-5
Polyethylene Tubes	2-6
Ultra-Clear Tubes	2-6

	Page
Cellulose Propionate Tubes	2-6
Stainless Steel Tubes	2-7
Conical Tubes	2-7
Bottles	2-7
Temperature Limits	2-8
Spacers and Floating Spacers	2-8
Adapters	2-10

SECTION 3: USING TUBES, BOTTLES, AND ACCESSORIES

Gradient Preparation	3-1
Cesium Chloride Gradients	3-2
General Filling and Sealing or Capping Requirements	3-3
Filling and Plugging OptiSeal Tubes	3-3
Filling the Tubes	3-5
Seating the Tube Plugs	3-7
Filling and Sealing Quick-Seal Tubes	3-8
Method A — With the Seal Guide	3-9
Method B — Without the Seal Guide	3-11
Filling Open-Top Tubes	3-12
Open-Top Polyallomer Tubes	3-12
Other Open-Top Tubes	3-12
Capping Tubes	3-14
Tube Cap Assemblies	3-14
Inspecting and Lubricating Tube Caps	3-19
Assembling Tube Caps	3-19
Filling and Capping Bottles	3-22

	Page
Sample Recovery	3-25
Capped Tubes	3-25
OptiSeal Tubes	3-25
Quick-Seal Tubes	3-28
Making Ultra-Clear Tubes Wettable	3-29
SECTION 4: USING FIXED ANGLE ROTORS	
Description	4-1
Tubes and Bottles	4-4
Rotor Preparation and Loading	4-4
Prerun Safety Checks	4-6
Rotor Preparation and Loading	4-6
Operation	4-7
Installing the Rotor	4-8
Removal and Sample Recovery	4-8
SECTION 5: USING SWINGING BUCKET ROTORS	
Description	5-1
Tubes and Bottles	5-4
Rotor Preparation and Loading	5-4
Prerun Safety Checks	5-4
Rotor Preparation and Loading	5-5
Operation	5-6
Installing the Rotor	5-6
Removal and Sample Recovery	5-8

SECTION 6: USING VERTICAL TUBE AND NEAR VERTICAL TUBE ROTORS

Description	6-1
Vertical Tube Rotors	6-1
Near Vertical Tube Rotors	6-2
Tubes and Bottles	6-4
Rotor Preparation and Loading	6-4
Prerun Safety Checks	6-4
Rotor Preparation and Loading	6-5
Operation	6-7
Installing the Rotor	6-8
Removal and Sample Recovery	6-8

SECTION 7: CARE AND MAINTENANCE

Rotor Care	7-1
Cleaning	7-2
Decontamination	7-3
Sterilization and Disinfection	7-4
Inspection	7-4
Field Rotor Inspection Program	7-5
Lubrication	7-5
Overspeed Disk Replacement	7-6
Tube, Bottle, and Accessory Care	7-6
Cleaning	7-6
Decontamination	7-7
Sterilization and Disinfection	7-7
Inspection	7-9
Tube and Bottle Storage	7-9
Removing Jammed or Collapsed Tubes	7-9

	Page
Tube Cap Care	7-10
Cleaning	7-10
Decontamination	7-11
Sterilization and Disinfection	7-12
Lubrication	7-12
Inspection	7-13
Nylon Insert Replacement	7-13
Returning a Rotor or Accessory to the Factory	7-14
Diagnostic Hints	7-15
Appendix A: Chemical Resistances for Beckman Coulter Centrifugation Products	A-1
Appendix B: Use of the ω^2t Integrator	B-1
Appendix C: The Use of Cesium Chloride Curves	C-1
Appendix D: Gradient Materials	D-1
Appendix E: Glossary of Terms	E-1
Appendix F: References	F-1
Warranty	

Illustrations

	Page
Figure 1-1. Fixed Angle, Swinging Bucket, Vertical Tube, and Near Vertical Tube Rotors	1-2
Figure 1-2. Particle Separation in Fixed Angle, Swinging Bucket, Vertical Tube, and Near Vertical Tube Rotors	1-5
Figure 1-3. Sedimentation Coefficients (in Svedberg Units) for Some Common Biological Materials	1-9
Figure 1-4. Nomogram	1-10
Figure 1-5. Arranging Tubes Symmetrically in a Rotor	1-14
Figure 3-1. Filling OptiSeal Tubes	3-5
Figure 3-2. The Cordless Quick-Seal Tube Topper	3-8
Figure 3-3. Tools Used to Assemble Tube Caps	3-20
Figure 3-4. Tube Cap Installation	3-22
Figure 3-5. Tube Cap Vise	3-23
Figure 4-1. Fixed Angle Rotors	4-2
Figure 4-2. Removal Tools Used in Fixed Angle Rotors	4-9
Figure 5-1. Swinging Bucket Rotors	5-2
Figure 5-2. Checking Hook-on Bucket Positions After the Rotor is Installed	5-7
Figure 6-1. Vertical Tube Rotors	6-3
Figure 6-2. Near Vertical Tube Rotors	6-3
Figure 6-3. Preparing a Vertical Tube or Near Vertical Tube Rotor	6-6

	Page
Figure B-1. The $s\omega^2t$ Charts for the SW 60 Ti Rotor	B-3
Figure C-1. Precipitation Curves for the Type 90 Ti Rotor	C-2
Figure C-2. CsCl Gradients at Equilibrium	C-3

	Page
Table 1-1. Beckman Coulter Preparative Rotors by Use	1-6
Table 2-1. Characteristics and Chemical Resistances of Tube and Bottle Materials	2-2
Table 2-2. Quick-Seal Tube Spacers	2-9
Table 2-3. Dimensions of Delrin Adapters.	2-11
Table 3-1. Filling and Capping Requirements for Tubes and Bottles	3-4
Table 3-2. OptiSeal Tubes and Accessories	3-6
Table 3-3. Tube Cap Assemblies for Open-Top Tubes in Fixed Angle Rotors ...	3-16
Table 3-4. Required Tools and Torque Values	3-21
Table 3-5. Available Bottles, Assembly and Operation	3-24
Table 4-1. General Specifications for Beckman Coulter Preparative Fixed Angle Rotors	4-3
Table 4-2. Maximum Run Speeds and Tube Volumes for Uncapped Tubes in Fixed Angle Rotors	4-5
Table 5-1. General Specifications for Beckman Coulter Preparative Swinging Bucket Rotors	5-3
Table 6-1. General Specifications for Beckman Coulter Preparative Vertical Tube and Near Vertical Tube Rotors	6-2
Table 6-2. Rotor Plugs and Tools Used for Vertical Tube and Near Vertical Tube Rotors	6-7

	Page
Table 7-1. Tube and Bottle Sterilization and Disinfection	7-8
Table D-1. Commonly Used Gradient Materials with Their Solvents	D-2
Table D-2. Density, Refractive Index, and Concentration Data— Cesium Chloride at 25°C, Molecular Weight = 168.37	D-3
Table D-3. Density, Refractive Index, and Concentration Data—Sucrose at 20°C, Molecular Weight = 342.3	D-4
Table D-4. Density Conversion for Cesium and Rubidium Salts at 20°C	D-5

Classification Program

All Beckman Coulter preparative ultracentrifuges are classified according to the size and protective barrier of the rotor chamber, the type of overspeed detection system, and the degree of updating the instruments have, if any. Preparative ultracentrifuges should have a decal above the rotor chamber opening on top of the instrument or on the chamber door, indicating their classification letter. Beckman Coulter rotors are then specified for use in particular instrument classes.

In June, 1984, a major reclassification program was established to ensure continued safety to users of older ultracentrifuges and/or rotors. This reclassification of instruments and rotors is outlined below. It is essential that you use this program to determine which rotors may be safely run in which instruments. (Rotors in parentheses are no longer manufactured.)



CAUTION

Rotors without mechanical overspeed devices should not be used in ultracentrifuges classified other than G, H, R, or S.

INSTRUMENT CLASSIFICATION	ROTORS THAT MAY BE USED IN THIS INSTRUMENT*
All Model L's, classified "A"	(Type 40), (Type 40.2), (Type 40.3), (SW 50.1), (SW 25.1), and (A1-15).
All Model L's, classified "B"	(Type 50 Ti), (Type 50.3 Ti), (Type 50), (Type 40), (Type 40.2), (Type 40.3), (SW 50.1), (SW 30), (SW 30.1), (SW 25.1), and zonals.
All Model L2-50's, classified "C"	(Type 50 Ti), (Type 50.3 Ti), (Type 50), (Type 40), (Type 40.2), (Type 40.3), Type 25, (Type 15), SW 41 Ti, (SW 30), (SW 30.1), SW 28, SW 28.1, (SW 27), (SW 27.1), (SW 25.1), (SW 25.2), and zonals.
All Model L2-50's, classified "D"	(Type 50 Ti), (Type 50.3 Ti), (Type 50), (Type 40), (Type 40.2), (Type 40.3), Type 25, (Type 15), (SW 50.1), SW 41 Ti, (SW 30), (SW 30.1), SW 28, SW 28.1, (SW 27), (SW 27.1), (SW 25.1), (SW 25.2), and zonals.
All Model L2-50's, classified "F"	(Type 50 Ti), Type 50.2 Ti, (Type 50.3 Ti), Type 50.4 Ti, (Type 50), Type 45 Ti, (Type 40), (Type 40.2), (Type 40.3), Type 25, (Type 15), (SW 50.1), SW 41 Ti, (SW 30), (SW 30.1), SW 28, SW 28.1, (SW 27), (SW 27.1), (SW 25.1), (SW 25.2), and zonals.
All Model L2-65's, classified "D"	(Type 50 Ti), (Type 50.3 Ti), (Type 50), (Type 40), (Type 40.2), (Type 40.3), Type 25, (Type 15), (SW 50.1), SW 41 Ti, (SW 30), (SW 30.1), SW 28, SW 28.1, (SW 27), (SW 27.1), (SW 25.1), (SW 25.2), and zonals.

* To the maximum speed of the ultracentrifuge as applicable.

INSTRUMENT CLASSIFICATION	ROTORS THAT MAY BE USED IN THIS INSTRUMENT*
All Model L2-65's, classified "F"	(Type 50 Ti), Type 50.2 Ti, (Type 50.3 Ti), (Type 50), Type 45 Ti, (Type 40), (Type 40.2), (Type 40.3), Type 25, (Type 15), (SW 50.1), SW 41 Ti, SW 28, SW 28.1, (SW 27), (SW 27.1), (SW 25.1), (SW 25.2), and zonals.
All Model L2-65B's and Model L2-75B's, classified "G"	(Type 50 Ti), Type 50.2 Ti, (Type 50.3 Ti), (Type 50), Type 45 Ti, (Type 40), (Type 40.2), (Type 40.3), Type 25, (SW 50.1), SW 41 Ti, SW 40 Ti, (SW 30), (SW 30.1), SW 28, SW 28.1, (SW 27), (SW 27.1), (SW 25.1), (SW 25.2), and zonals.
All Model L3-40's and Model L3-50's, classified "F"	(Type 50 Ti), Type 50.2 Ti, (Type 50.3 Ti), (Type 50), Type 45 Ti, (Type 40), (Type 40.2), (Type 40.3), Type 25, (SW 50.1), SW 41 Ti, (SW 30), (SW 30.1), SW 28, SW 28.1, (SW 27), (SW 27.1), (SW 25.1), (SW 25.2), and zonals.
All Model L3-40's and Model L3-50's, classified "G"	(Type 50 Ti), Type 50.2 Ti, (Type 50.3 Ti), (Type 50), Type 45 Ti, Type 42.2 Ti, (Type 40), (Type 40.2), (Type 40.3), Type 25, (SW 50.1), SW 41 Ti, (SW 30), (SW 30.1), SW 28, SW 28.1, (SW 27), (SW 27.1), (SW 25.1), (SW 25.2), and zonals.
Model L4's, classified "Q"	(Type 50 Ti), (Type 50.3 Ti), (Type 50), Type 45 Ti, (Type 40), (Type 40.2), (Type 40.3), (SW 50.1), (SW 30), (SW 30.1), (SW 25.1), and zonals.
Model L5's, L5B's, L8's, and L8M's, all classified "H"	Any Beckman Coulter preparative rotor (including zonal and continuous flow rotors) EXCEPT the following: (a) all (Type 15) rotors and (b) all (Type 35) and (Type 42.1) rotors with serial numbers 1299 or lower (see Special Action below). (Type 16) and (Type 28) rotors in Model L8's and L8M's only.
Model L7's and Optima L's, all classified "R"	Any Beckman Coulter preparative rotor EXCEPT the (Type 15) rotor and zonal and continuous flow rotors.
Optima XL's, and L-XP's classified "S"	Any Beckman Coulter preparative rotor, including zonal and continuous flow rotors.

Special Action on Older Type 35 and Type 42.1 Rotors

We have found that there is a high risk associated with Type 35 rotor and Type 42.1 rotors having serial numbers 1299 and lower. These rotors were originally stamped "Type 42" or "Type 50.2" and were derated over 15 years ago. THESE ROTORS ARE NOW OVER 20 YEARS OLD AND MUST BE RETIRED IMMEDIATELY, REGARDLESS OF THE INSTRUMENTS IN WHICH THEY ARE USED.

*To the maximum speed of the ultracentrifuge as applicable.



This section is an introduction to the Beckman Coulter family of preparative ultracentrifuge rotors, providing general information on rotor design, selection, and operation. Rotor designs described are fixed angle, swinging bucket, vertical tube, and near vertical tube type. Specific instructions for using each type of rotor are contained in Sections 4 through 6. Care and maintenance information for all of these rotors is contained in Section 7. Analytical, continuous flow, and zonal rotors are not covered in this manual; they are described in detail in their respective rotor instruction manuals.

GENERAL DESCRIPTION

ROTOR DESIGNATIONS

Beckman Coulter preparative rotors are named according to the type of rotor, the material composition, and the rotor's maximum allowable revolutions per minute (in thousands), referred to as rated speed. For example, the SW 28 is a swinging bucket rotor with a maximum speed of 28 000 rpm. Decimal units that are sometimes part of the rotor name, as in the Type 50.2 Ti and the Type 50.4 Ti, make it possible to distinguish between different rotors that have the same maximum allowable speed. An example of each rotor type is shown in Figure 1-1.

Tubes in *fixed angle rotors* (designated **Type**) are held at an angle to the axis of rotation in numbered tube cavities. The bodies of some large, heavy rotors are fluted to eliminate unnecessary weight and minimize stresses.

In *swinging bucket rotors* (designated **SW**), containers are held in rotor buckets or attached to the rotor body by hinge pins or a crossbar. The buckets swing out to a horizontal position as the rotor accelerates, then seat against the rotor body for support.

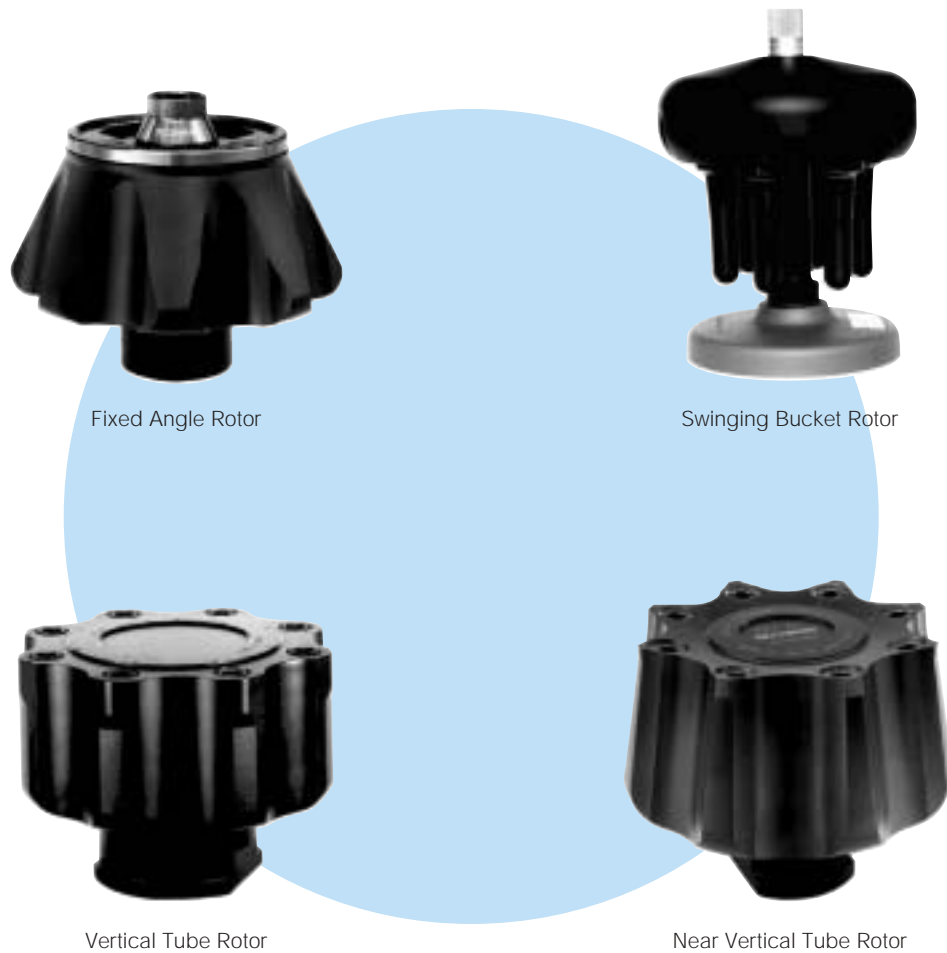

Figure 1-1. Fixed Angle, Swinging Bucket, Vertical Tube, and Near Vertical Tube Rotors

In *vertical tube rotors* (designated **V**), tubes are held parallel to the axis of rotation. These rotors (and the near-vertical tube rotors) have plugs, screwed into the rotor cavities over sealed tubes, that restrain the tubes in the cavities and provide support for the hydrostatic forces generated by centrifugation.

Tubes in *near vertical tube rotors* (designated **NV**), are also held at an angle to the axis of rotation in numbered tube cavities. However, the reduced tube angle of these rotors (typically 7 to 10 degrees) reduces run times from fixed angle rotors (with tube angles of 20 to 45 degrees) while allowing components that do not band under separation conditions to either pellet to the bottom or float to the top of the tube. As in vertical tube rotors, rotor plugs are used in these rotors to restrain the tubes in the cavities and provide support for the hydrostatic forces generated by centrifugation.

MATERIALS

Beckman Coulter rotors are made from either aluminum or titanium, or from fiber-reinforced composites. A titanium rotor is designated by T or Ti, as in the Type 100 Ti, the SW 55 Ti, or the NVT 90 rotor. A fiber composite rotor is designated by C (as in VC 53), and an aluminum-composite rotor is designated by AC (as in VAC 50). Rotors without the T, Ti, C, or AC designation (such as the Type 25) are fabricated from an aluminum alloy. Titanium rotors are stronger and more chemical resistant than the aluminum rotors.

Exterior surfaces of titanium and composite rotors are finished with black polyurethane paint. Titanium buckets and lids of high-performance rotors are usually painted red for identification.

On some swinging bucket rotors a solid film lubricant coating is added to the bucket flange where the bucket contacts the rotor body. The purpose of the coating, which is a dull gray in color, is to minimize friction and enable the bucket to swing into the rotor bucket pocket more smoothly. With use and handling, all or part of this coating may wear off; this should not affect the rotor performance, as the bucket swing-up will wear in with use.

Aluminum rotors are anodized to protect the metal from corrosion. The anodized coating is a thin, tough layer of aluminum oxide formed electrochemically in the final stages of rotor fabrication. A colored dye may be applied over the oxide for rotor identification.

The O-rings or gaskets in fixed angle rotor assemblies or lids, and in swinging bucket caps, are usually made of Buna N elastomer and maintain atmospheric pressure in the rotor if they are kept clean and lightly coated with silicone vacuum grease. Plug gaskets in vertical tube or near vertical tube rotors are made of Hytrel® and do not require coating.

DRIVE PINS

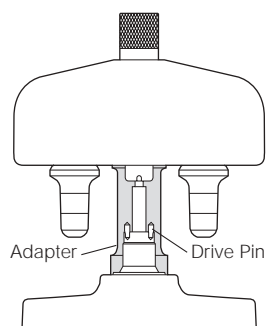

Relatively light rotors have drive pins in the drive hole that mesh with pins on the ultracentrifuge drive hub when the rotor is installed to ensure that the rotor does not slip on the hub during initial acceleration. (Heavier rotors do not require the use of drive pins.) For swinging bucket rotors, an indentation on the rotor adapter or the position of the mechanical overspeed cartridges (see **Overspeed Protection**, below) indicates the location of the drive pins. In this way, the pins can be properly aligned without lifting the rotor and dislocating the buckets.

ROTOR SELECTION

Selection of a rotor depends on a variety of conditions, such as sample volume, number of sample components to be separated, particle size, desired run time, desired quality of separation, type of separation, and the centrifuge in use. Fixed angle, swinging bucket, vertical tube, and near vertical tube rotors are designed to provide optimal separations for a variety of sample types. (For especially large sample volumes, continuous flow and zonal rotors are available.)

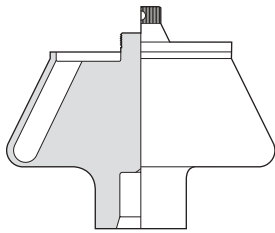

- *Fixed angle rotors* are general-purpose rotors that are especially useful for pelleting subcellular particles and in short-column banding of viruses and subcellular organelles. Tubes are held at an angle (usually 20 to 45 degrees) to the axis of rotation in numbered tube cavities. The tube angle shortens the particle pathlength (see Figure 1-2), compared to swinging bucket rotors, resulting in reduced run times. Refer to Section 4 for specific information about the use of fixed angle rotors.

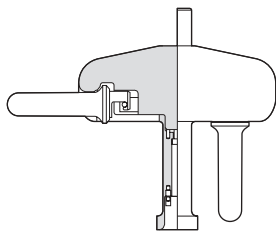

- *Swinging bucket rotors* are used for pelleting, isopycnic studies (separation as a function of density), and rate zonal studies (separation as a function of sedimentation coefficient). Swinging bucket rotors are best applied for rate zonal studies in which maximum resolution of sample zones are needed, or pelleting runs where it is desirable for the pellet to be in the exact center of the tube bottom. Gradients of all shapes and steepness can be used. Refer to Section 5 for specific information about the use of swinging bucket rotors.

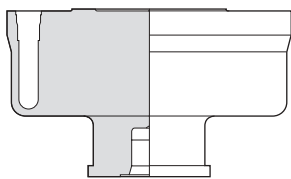

- *Vertical tube rotors* hold tubes parallel to the axis of rotation; therefore, bands separate across the diameter of the tube rather than down the length of the tube (see Figure 1-2). Vertical tube rotors are useful for isopycnic and, in some cases, rate zonal separations when run time reduction is important. Only Quick-Seal[®] and OptiSeal[™] tubes are used in vertical tube rotors, making tube caps unnecessary. Refer to Section 6 for specific information about the use of vertical tube rotors.

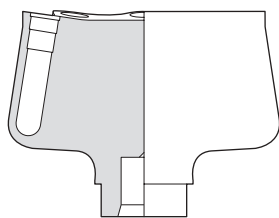

- *Near vertical tube rotors* are designed for gradient centrifugation when there are components in a sample mixture that do not participate in the gradient. The reduced tube angle of these rotors significantly reduces run times from the more conventional fixed angle rotors, while allowing components that do not band under separation conditions to either pellet to the bottom or float to the top of the tube. Like the vertical tube rotors, near vertical tube rotors use only Quick-Seal and OptiSeal tubes. Refer to Section 6 for specific information about the use of near vertical tube rotors.

Table 1-1 lists Beckman Coulter preparative rotors by use.

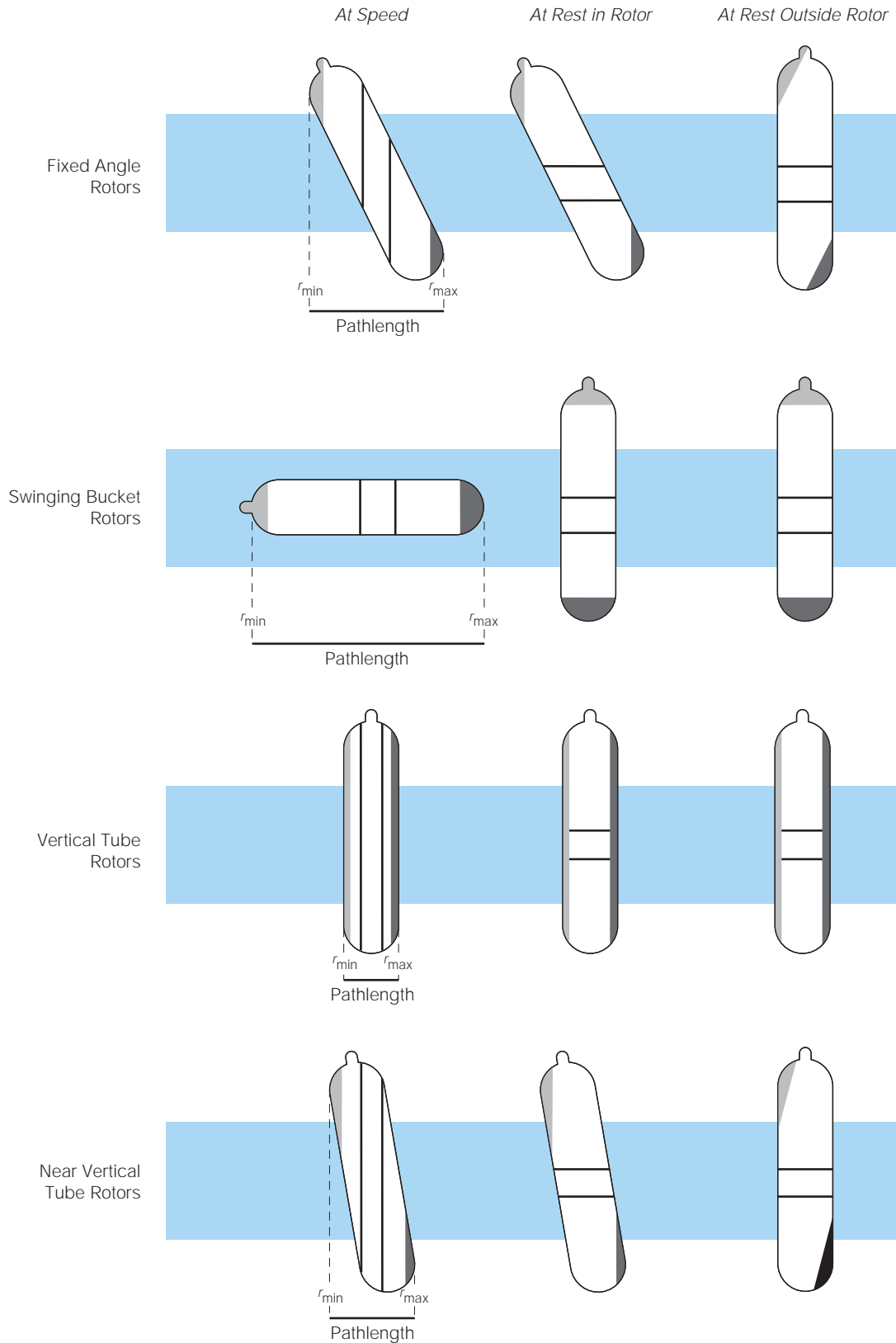

Figure 1-2. Particle Separation in Fixed Angle, Swinging Bucket, Vertical Tube, and Near Vertical Tube Rotors. Dark gray represents pelleted material, light gray is floating components, and bands are indicated by black lines.

Table I-1. Beckman Coulter Preparative Rotors by Use. Rotors listed in parentheses are no longer manufactured.

Rotor	Maximum Speed ^a (rpm)	Relative Centrifugal Field ^b ($\times g$) at r_{\max}	k Factor	Number of Tubes \times Nominal Capacity (mL) of Largest Tube	Nominal Rotor Capacity (mL)	For Use in Instruments Classified
Rotors for Centrifuging Extremely Small Particles						
NVT 100	100 000	750 000	8	8 \times 5.1	40.8	R, S
Type 100 Ti	100 000	802 400	15	8 \times 6.8	54	R, S
NVT 90	90 000	645 000	10	8 \times 5.1	40.8	H,R,S
Type 90 Ti	90 000	694 000	25	8 \times 13.5	108	H,R,S
VTi 90	90 000	645 000	6	8 \times 5.1	40.8	H,R,S
(Type 80 Ti)	80 000	602 000	28	8 \times 13.5	108	H,R,S
(VTi 80)	80 000	510 000	8	8 \times 5.1	40.8	H,R,S
(Type 75 Ti)	75 000	502 000	35	8 \times 13.5	108	G ^c ,H,R,S
NVT 65.2	65 000	416 000	16	16 \times 5.1	81.6	H,R,S
NVT 65	65 000	402 000	21	8 \times 13.5	108	H,R,S
VTi 65.2	65 000	416 000	10	16 \times 5.1	81.6	H,R,S
VTi 65.1	65 000	402 000	13	8 \times 13.5	108	H,R,S
(VTi 65)	65 000	404 000	10	8 \times 5.1	40.8	H,R,S
(Type 65)	65 000	368 000	45	8 \times 13.5	108	G ^c ,H,R,S
(Type 50 Ti)	50 000	226 000	78	12 \times 13.5	162	G ^c ,H,R,S
Rotors for Centrifuging Small Particles in Volume						
Type 70 Ti	70 000	504 000	44	8 \times 38.5	308	G ^c ,H,R,S
(Type 60 Ti)	60 000	362 000	63	8 \times 38.5	308	G ^c ,H,R,S
(Type 55.2 Ti)	55 000	340 000	64	10 \times 38.5	385	G ^c ,H,R,S
(VC 53)	53 000	249 000	36	8 \times 39	312	H,R,S
Type 50.2 Ti	50 000	302 000	69	12 \times 39	468	F,G ^c ,H,R,S
(VAC 50)	50 000	242 000	36	10 \times 39	390	H,R,S
VTi 50	50 000	242 000	36	8 \times 39	312	H,R,S
Type 45 Ti	45 000	235 000	133	6 \times 94	564	F,G ^c ,H,Q,R,S
(Type 42.1)	42 000	195 000	133	8 \times 38.5	308	H,R,S
(Type 35)	35 000	143 000	225	6 \times 94	564	H,R,S
(Type 28)	28 000	94 800	393	8 \times 40	320	H ^d ,R,S
Rotors for Differential Flotation						
Type 50.4 Ti	50 000	312 000 ^e	33	44 \times 6.5	286	G ^c ,H,R,S
(Type 50.3 Ti)	50 000	223 000	49	18 \times 6.5	117	B,C,D,F,G,H,Q,R,S
Type 42.2 Ti	42 000	223 000	12	72 \times 230 μ L	16.5	G ^c ,H,R,S
Type 25	25 000	92 500 ^f	62	100 \times 1	100	C,D,F,G,H,R,S

Continued —

Table 1-1. Beckman Coulter Preparative Rotors by Use (continued)

Rotor	Maximum Speed ^a (rpm)	Relative Centrifugal Field ^b ($\times g$) at r_{\max}	k Factor	Number of Tubes \times Nominal Capacity (mL) of Largest Tube	Nominal Rotor Capacity (mL)	For Use in Instruments Classified
Rotors for Centrifuging Large Particles						
Type 70.1 Ti	70 000	450 000	36	12 \times 13.5	162	G ^c ,H,R,S
(Type 50)	50 000	196 000	65	10 \times 10	100	A,B,C,D,F,G,H,Q,R,S
(Type 40)	40 000	145 000	122	12 \times 13.5	162	A,B,C,D,F,G,H,Q,R,S
(Type 30)	30 000	106 000	213	12 \times 38.5	462	H,R,S
Rotors for Centrifuging Large Particles in Volume						
(Type 21)	21 000	60 000	402	10 \times 94	940	H,R,S
Type 19	19 000	53 900	951	6 \times 250	1500	H,R,S
(Type 16)	16 000	39 300	1350	6 \times 250	1500	H,R,S
Rotors for Isopycnic and Rate-Zonal Gradients						
(SW 65 Ti)	65 000	421 000	46	3 \times 5	15	G ^c ,H,R,S
SW 60 Ti	60 000	485 000	45	6 \times 4	24	G ^c ,H,R,S
SW 55 Ti	55 000	368 000	48	6 \times 5	30	G ^c ,H,R,S
(SW 50.1)	50 000	300 000	59	6 \times 5	30	A,B,C,D,F,G,H,Q,R,S
Rotors with Long, Slender Tubes for Rate-Zonal Gradients						
SW 41 Ti	41 000	288 000	124	6 \times 13.2	79.2	C,D,F,G,H,R,S
SW 40 Ti	40 000	285 000	137	6 \times 14	84	G ^c ,H,R,S
SW 32 Ti	32 000	175 000	204	6 \times 38.5	231	H, R, S
SW 28.1 ^g	28 000	150 000	276	6 \times 17	102	C,D,F,G,H,R,S
Rotors for Larger-Volume Density Gradients						
SW 32.1	32 000	187 000	228	6 \times 17	102	H, R, S
(SW 30.1)	30 000	124 000	138	6 \times 8	48	B,C,D,F,G,H,R,S
(SW 30)	30 000	124 000	138	6 \times 20	120	B,C,D,F,G,H,R,S
SW 28 ^g	28 000	141 000	245	6 \times 38.5	231	C,D,F,G,H,R,S
(SW 25.1)	25 000	90 400	337	3 \times 34	102	A,B,C,D,F,G,H,Q,R,S

^a Maximum speeds are based on a solution density of 1.2 g/mL in all rotors except for the Type 60 Ti, Type 42.1, and the Type 35, which are rated for a density of 1.5 g/mL; and the near vertical tube and vertical tube rotors, which are rated for a density of 1.7 g/mL.

^b Relative Centrifugal Field (RCF) is the ratio of the centrifugal acceleration at a specified radius and speed ($r\omega^2$) to the standard acceleration of gravity (g) according to the following formula: $RCF = r\omega^2/g$ where r is the radius in millimeters, ω is the angular velocity in radians per second ($2\pi\text{RPM}/60$), and g is the standard acceleration of gravity (9807 mm/s²). After substitution: $RCF = 1.12r (\text{RPM}/100)^2$.

^c Class G, Model L3 only.

^d Except L5 and L5B.

^e Maximum RCF measured at outer row.

^f Maximum RCF measured at the third (outermost) row. Radial distances are those of the third row.

^g (SW 28.1M) and (SW 28M) rotors (no longer manufactured) are specially modified versions of the SW 28.1 and SW 28 rotors, and are equipped with a mechanical overspeed system. These rotors are otherwise identical to the SW 28.1 and SW 28 rotors.

PELLETING (DIFFERENTIAL SEPARATION)

Pelleting separates particles of different sedimentation coefficients, the largest particles in the sample traveling to the bottom of the tube first. Differential centrifugation is the successive pelleting of particles of decreasing sedimentation velocities, using increasingly higher forces and/or long run times. The relative pelleting efficiency of each rotor is measured by its k factor (clearing factor):

$$k = \frac{\ln(r_{\max}/r_{\min})}{\omega^2} \times \frac{10^{13}}{3600} \quad (1)$$

where ω is the angular velocity of the rotor in radians per second ($2\pi\text{RPM}/60$, or $\omega = 0.10472 \times \text{rpm}$), r_{\max} is the maximum radius, and r_{\min} is the minimum radius.

After substitution,

$$k = \frac{(2.533 \times 10^{11}) \ln(r_{\max}/r_{\min})}{\text{rpm}^2} \quad (2)$$

This factor can be used in the following equation to estimate the time t (in hours) required for pelleting:

$$t = \frac{k}{s} \quad (3)$$

where s is the sedimentation coefficient¹ of the particle of interest in Svedberg units. (Because s values in seconds are such small numbers, they are generally expressed in Svedberg units (S), where 1 S is equal to 10^{-13} seconds). It is usual practice to use the standard sedimentation coefficient $s_{20,\omega}$ based on sedimentation in water at 20°C. Clearing factors can be calculated at speeds other than maximum rated speed by use of the following formula:

$$k_{\text{adj}} = k \left(\frac{\text{rated speed of rotor}}{\text{actual run speed}} \right)^2 \quad (4)$$

Run times can also be calculated from data established in prior experiments when the k factor of the previous rotor is known. For any two rotors, a and b:

$$\frac{t_a}{t_b} = \frac{k_a}{k_b} \quad (5)$$

where the k factors have been adjusted for the actual run speed used.

¹ $1 s = dr/dt \times 1/w^2r$, where dr/dt is the sedimentation velocity.

Figure 1-3 lists sedimentation coefficients for some common biological materials. The *k* factors at maximum speeds for Beckman Coulter preparative rotors are provided in the table of general specifications in each rotor use section.

The centrifugal force exerted at a given radius in a rotor is a function of the rotor speed. The nomogram in Figure 1-4 allows you to determine relative centrifugal field (RCF) for a given radius and rotor speed.

Run times can be shortened (in some rotors) by using the *g*-Max™ system. The short pathlength means less distance for particles to travel in the portion of the tube experiencing greatest centrifugal force, and hence shortened run times. Run times can also be shortened (in some rotors) by using partially filled thickwall polyallomer

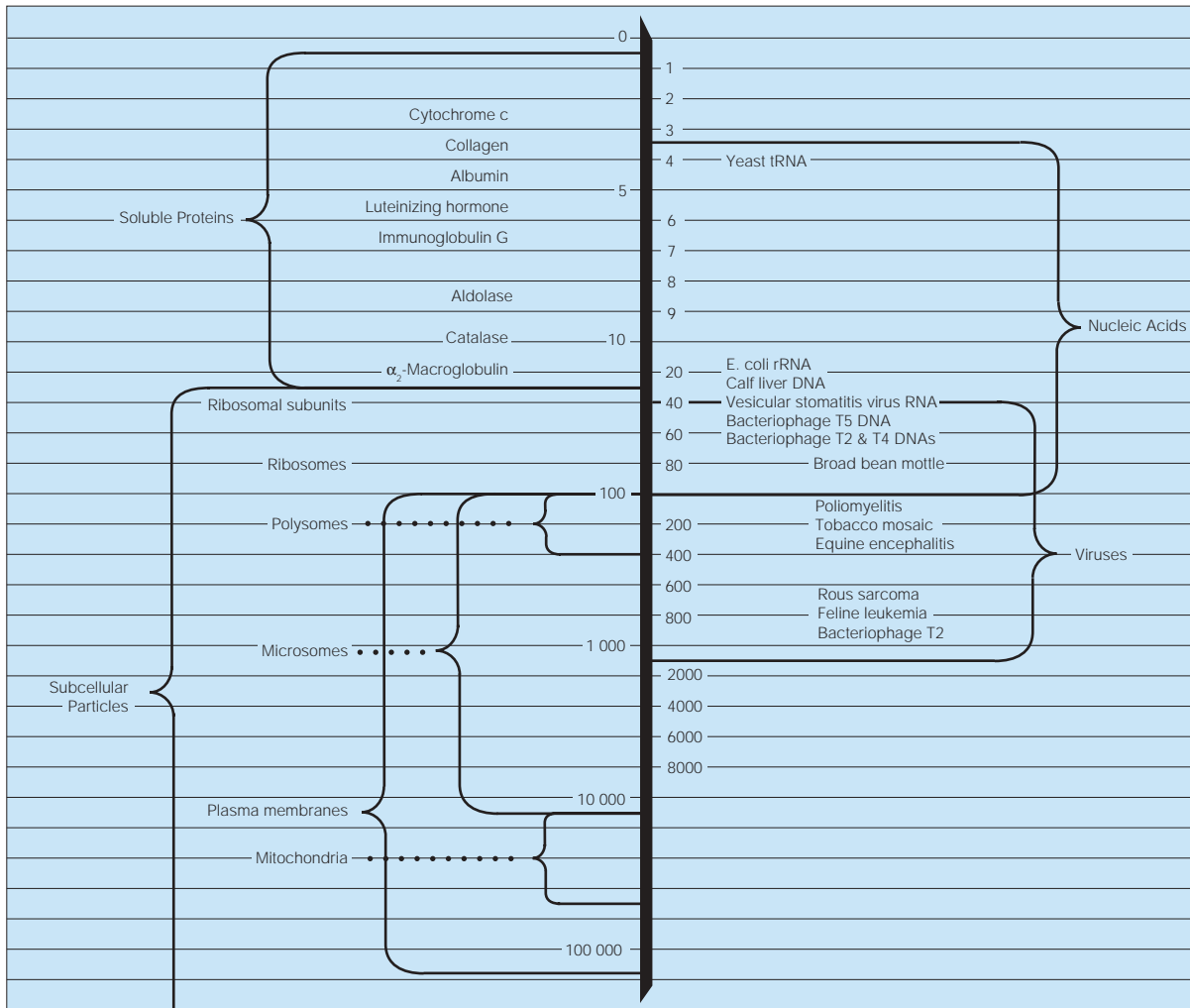

Figure 1-3. Sedimentation Coefficients (in Svedberg Units) for Some Common Biological Materials

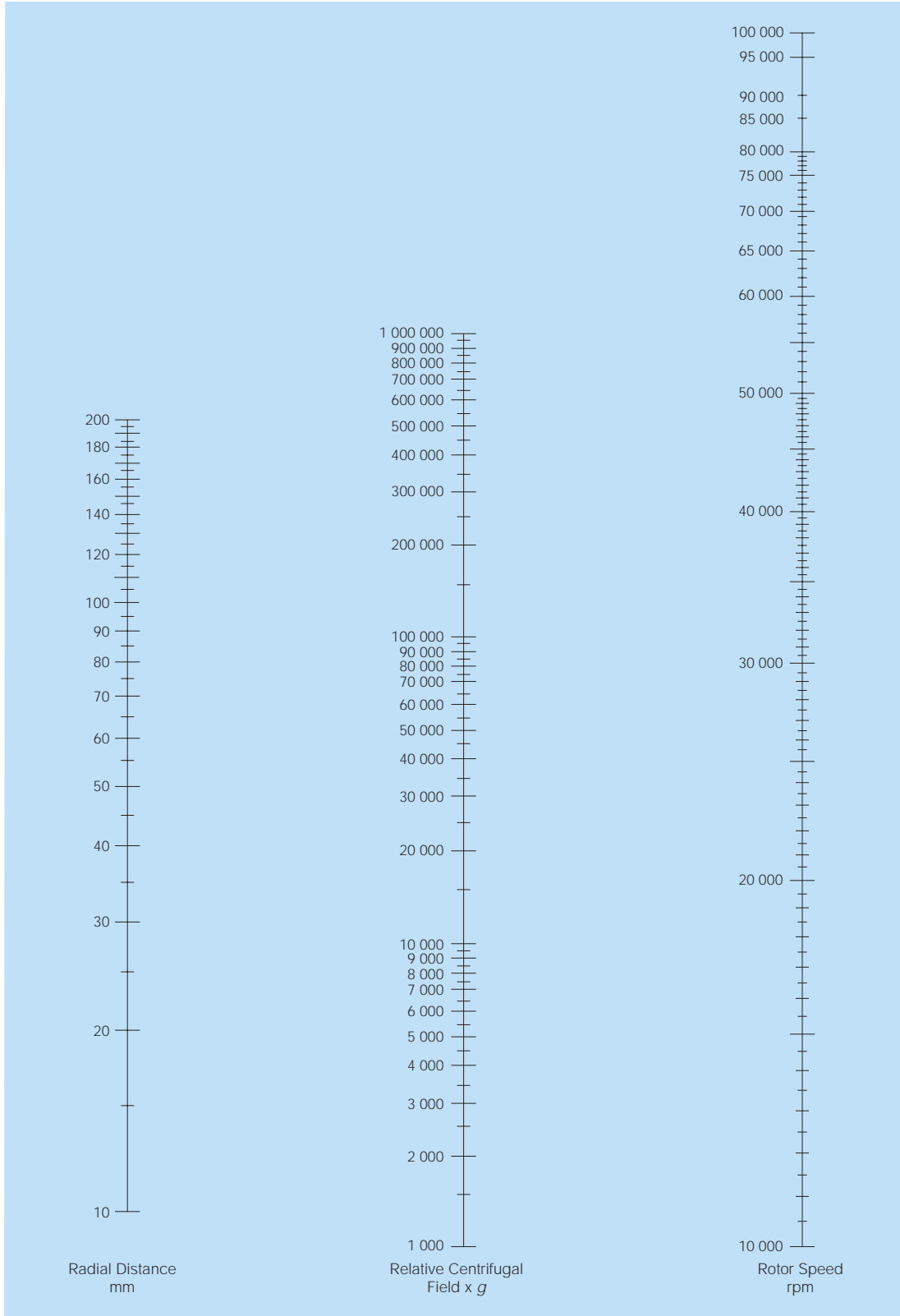

Figure 1-4. Nomogram: Align a straightedge through known values in two columns; read the figure where the straightedge intersects the third column.

and polycarbonate tubes. The k factors for half-filled tubes can be calculated by using an approximate r_{\max} and r_{av} in k -factor equation (1).

ISOPYCNIC SEPARATIONS

A sedimentation-equilibrium, or isopycnic, method separates particles on the basis of particle buoyant density. Each component in the sample travels through the gradient until it reaches an equilibrium position. Particle velocity due to differences in density is given in the following expression:

$$v = \left[\frac{d^2(\rho_p - \rho_c)}{18\mu} \right] \times g \quad (6)$$

where

v = sedimentation velocity (dr/dt)

d = particle diameter

ρ_p = particle density

ρ_c = solution density

μ = viscosity of liquid media

g = standard acceleration of gravity

At equilibrium, $\rho_p - \rho_c$ is zero, and particle velocity is therefore zero.

The gradient may be preformed before the run or generated during centrifugation. For gradients formed by centrifugation, the time it takes to form a gradient depends on the sedimentation and diffusion coefficients of the gradient material, the pathlength, and the rotor speed. For a given gradient material, the shorter the pathlength and the higher the rotor speed, the faster the gradient will form. In general, the time required for gradients to reach equilibrium in swinging bucket rotors will be longer than in fixed angle rotors. One way to reduce run times is to use partially filled tubes. Refer to the appropriate rotor instruction manual to determine the maximum allowable speed and solution density when using partially filled tubes.

RATE ZONAL SEPARATIONS

Particle separation achieved with rate zonal separation is a function of the particles' sedimentation coefficient (density, size, and shape) and viscosity of the gradient material. Sucrose is especially useful as a gradient material for rate zonal separation because its physical characteristics are well known and it is readily available. Samples are layered on top of the gradient. Under centrifugal force, particles migrate as zones. Rate zonal separation is time dependent; if the particles are more dense than the most dense portion of the gradient, some or all of the particles will pellet unless the run is stopped at the appropriate time.

A separation is sometimes a combination of rate zonal and isopycnic. Depending on particle buoyant densities and sedimentation coefficients, some particles may be separated by their differential rates of sedimentation, while others may reach their isopycnic point in the gradient.

Clearing factors of swinging bucket rotors at maximum speeds and various particle densities have been calculated for 5 to 20% (wt/wt) linear sucrose gradients at 5°C. These are called k' factor, and are given in Table 5-1 in Section 5. These constants can be used to estimate the time, t (in hours), required to move a zone of particles of known sedimentation coefficient and density to the bottom of a 5 to 20% gradient:

$$t = \frac{k'}{s} \quad (7)$$

where s is the sedimentation coefficient in Svedberg units, S . A more accurate way to estimate run times in rate zonal studies is to use the $s\omega^2t$ charts, available in *Use of the ω^2t Integrator* (publication DS-528). If the values of s and ω^2 are known, and gradients are either 5 to 20% or 10 to 30% (wt/wt) sucrose, you can use the charts to calculate the run time, t . Conversely, if the value of ω^2t is known, sedimentation coefficients can be estimated from zone positions. Refer to Appendix B of this manual for an explanation of the $s\omega^2t$ charts.

In most cases, when banding two or three components by rate zonal separation, run times can be considerably reduced by using reduced fill levels. Tubes are partially filled with gradient, but the sample volume is not changed (however, gradient capacity will be reduced). Thickwall tubes should be used when this technique is employed, since thinwall tubes will collapse if not full.

If swinging bucket rotors are used with preformed shallow gradients (<5 to 20%), or if fixed angle, vertical tube, or near vertical tube

rotors are used with any preformed gradient, use the slow acceleration control on your ultracentrifuge. Slow acceleration will protect the sample-to-gradient interface, and slow deceleration will maintain the integrity of the separation during the reorientation process.

GENERAL OPERATING INFORMATION

Careful centrifugation technique is essential, because forces generated in high-speed centrifugation can be enormous. For example, 1 gram at the bottom of an SW 60 Ti rotor bucket, rotating at 60 000 rpm, exerts the gravitational equivalent of 0.5 ton of centrifugal mass at the bottom of the bucket.

Note the classification letter of the ultracentrifuge to be used, and be sure the rotor is appropriate for the instrument (see the CLASSIFICATION PROGRAM chart at the beginning of this manual and Table 1-1). Acceptable classification letters are engraved on rotor lids, handles, stands, or bodies.

NOTE

Specific information about filling, sealing, and capping containers, loading rotors, etc., can be found in later sections.

ROTOR BALANCE

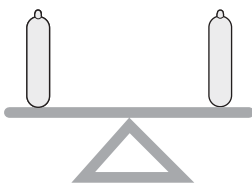

The mass of a properly loaded rotor will be evenly distributed on the ultracentrifuge drive hub, causing the rotor to turn smoothly with the drive. An improperly loaded rotor will be unbalanced; consistent running of unbalanced rotors will reduce ultracentrifuge drive life. To balance the rotor load, fill all opposing tubes to the same level with liquid of the same density. Weight of opposing tubes must be distributed equally. Place tubes in the rotor symmetrically, as illustrated in Figure 1-5.

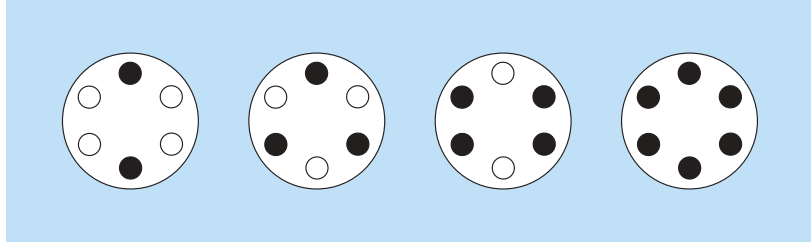

Figure 1-5. Arranging Tubes Symmetrically in a Rotor. For example, two, three, four, or six tubes can be arranged symmetrically in a six-place rotor.



CAUTION

For swinging bucket rotors, attach ALL buckets, whether loaded or empty. For vertical tube and near vertical tube rotors, insert spacers and rotor plugs ONLY in holes containing loaded tubes.

If sample quantity is limited and the rotor is not balanced, do one of the following to balance the rotor, depending on the rotor in use:

- Load the opposite rotor cavities or buckets with tubes containing a liquid of the same density as opposing tubes.
- Use smaller tubes with adapters or smaller Quick-Seal tubes with floating spacers to distribute the sample symmetrically.
- Use thickwall tubes partially filled to distribute sample to additional tubes.
- Layer a low-density, immiscible liquid, such as mineral oil, on top of the sample to fill opposing tubes to the same level. (Do not use an oil overlay in Ultra-Clear tubes.)

OVERSPEED PROTECTION

Rotors are specifically designed to withstand a maximum load (that is, volume and density of the rotor contents) at maximum rated speed. At greater speeds, or at rated speeds with heavier loads, rotors are subject to failure. It is the operator's responsibility to limit rotor speed when centrifuging dense solutions or when using heavy tubes; refer to ALLOWABLE RUN SPEEDS, below.

Rotors are protected from exceeding their maximum rated speed to help prevent failure and damage to the rotor and the instrument. Two overspeed protection systems are used in Beckman Coulter preparative ultracentrifuges.

- Optima L and LE (classified R) and Optima XL and L-XP (classified S), as well as Models L2-65B, L2-75B, and L3 (classified G), Models L5, L5B, L8, and L8M (classified H), and Model L7 (classified R), have a photoelectric overspeed system. This system includes a photoelectric device in the rotor chamber next to the drive hub and an overspeed disk on the rotor bottom.
- Earlier model ultracentrifuges—classified other than G, H, R, or S (and some F)—have a mechanical overspeed system.

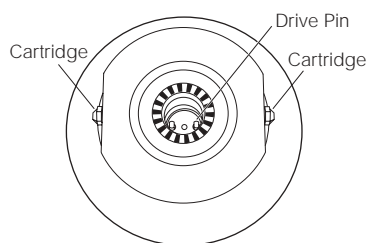
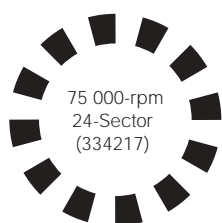

All Beckman Coulter preparative rotors are shipped with an overspeed disk attached, and are therefore protected from overspeeding in instruments with the photoelectric system. These instruments will not operate unless an overspeed disk is attached to the installed rotor. The disk has alternating sectors of reflecting and nonreflecting material. The number of sectors on the disk is a function of the rotor's maximum allowable speed. During centrifugation, if the reflective segments pass over the photoelectric pickup faster than the indicated set speed, the drive will automatically decelerate to the allowed speed.

The earlier model ultracentrifuges—classified A, B, C, D, N, O, P, Q, and some F)—with the mechanical overspeed system have a knockout pin in the rotor chamber. Rotors that are equipped for the mechanical system have overspeed cartridges installed in the sides of the rotor base. If overspeeding occurs, a small pin is forced out of the cartridge and knocks out the overspeed pin in the chamber, causing the instrument to shut down.



CAUTION

Rotors without mechanical overspeed cartridges should not be used in ultracentrifuges classified other than G, H, R, or S.

The overspeed device should be replaced if a rotor is regularly being used at speeds below its rated speed due to the use of adapters, stainless steel tubes, CsCl gradients, etc. Instructions for replacing overspeed disks are provided in Section 7 of this manual.

ALLOWABLE RUN SPEEDS

Under some conditions, the maximum allowable speed of the rotor (indicated by the rotor name) must be reduced to ensure that neither the rotor nor the labware are overstressed during centrifugation. Check the recommended run speed for your rotor before centrifuging dense solutions, CsCl gradients, stainless steel tubes, polycarbonate bottles, uncapped plastic tubes in fixed angle rotors, and sleeve-type adapters.

- *Dense Solutions.* To protect the rotor from excessive stresses due to the added load, reduce run speed when centrifuging a solution with a density greater than the allowable density rating of the rotor (specified in the rotor instruction manual). When using dense solutions in *plastic labware*, determine maximum run speed using the following square-root reduction formula:

$$\text{reduced run speed} = \text{maximum rated speed} \sqrt{\frac{A}{B}} \quad (8)$$

where A is the maximum permissible density of the tube contents for a particular rotor (from the rotor instruction manual), and B is the actual density of the tube contents to be centrifuged.

When using dense solutions in *stainless steel tubes*, refer to the individual rotor instruction manual or *Run Speeds for Stainless Steel Tubes* (publication L5-TB-072) for allowable speeds.

- *Cesium Chloride Gradients.* Run speed often must be reduced to avoid the precipitation of CsCl during centrifugation of concentrated CsCl solutions. Use the CsCl curves provided in the individual rotor instruction manual to determine run speeds. An example of the use of CsCl curves is in Appendix C of this manual.
- *Uncapped Thickwall Plastic Tubes in Fixed Angle Rotors.* Speed limitations are required to prevent tube collapse when thickwall plastic tubes are centrifuged without the support of tube caps in fixed angle rotors (refer to Section 4).
- *Polycarbonate and Polypropylene Bottles.* Speed limitations are required to prevent the bottle material from overstressing and deforming (refer to Section 2).
- *Adapters.* When small tubes are used with Delrin adapters, run speed often must be reduced due to the increased density of Delrin (1.4 g/mL). The formula for speed reduction is described in Section 2. Consult individual rotor manuals for allowable run speeds.

- *Stainless Steel Tubes.* Reduce run speed when centrifuging stainless steel tubes to prevent the rotor from overstressing due to the added weight. The criteria for speed reduction percentage depends on the tube-cap material and the strength of the rotor in use; consult the individual rotor manual or publication L5-TB-072.



Tubes, Bottles, and Accessories

This section describes various labware used in Beckman Coulter preparative rotors. General instructions for using containers follow in Section 3. Care and maintenance instructions are in Section 7. General rotor use instructions are in Sections 4 through 6. The individual rotor manual that comes with each rotor provides specific instructions on the tubes, bottles, and accessories that can be used in a particular rotor.¹ A table of chemical resistances can be found in Appendix A of this manual.

LABWARE SELECTION CRITERIA

No single tube or bottle design or material meets all application requirements. Labware choice is usually based on a number of factors.

- The centrifugation technique to be used, including the rotor in use, volume of sample to be centrifuged, need for sterilization, importance of band visibility, and so forth
- Chemical resistance—the nature of the sample and any solvent or gradient media
- Temperature and speed considerations
- Whether tubes or bottles are to be reused

Table 2-1 contains an overview of some of the characteristics of tube and bottle materials.

¹ A complete list of tubes, bottles, and accessories is provided in the latest edition of the Beckman Coulter *Ultracentrifuge Rotors, Tubes & Accessories* catalog (BR-8101), available at www.beckmancoulter.com.

Table 2-1. Characteristics and Chemical Resistances of Tube and Bottle Materials.
Refer to Appendix A for information about specific solutions.

Tube or Bottle Type	Optical Property	Puncturable	Silceable	Reusable	Acids (dilute or weak)	Acids (strong)	Alcohols (aliphatic)	Aldehydes	Bases	Esters	Hydrocarbons (aliphatic)	Hydrocarbons (aromatic and halogenated)	Ketones	Oxidizing Agents (strong)	Salts
thinwall polyallomer	transparent	yes	yes	no	S	U	U	M	S	U	U	U	U	U	S
thickwall polyallomer	translucent	no	no*	yes	S	S	S	M	S	M	M	U	M	U	S
Ultra-Clear	transparent	yes	yes	no	S	U	U	S	U	U	U	U	U	U	M
polycarbonate	transparent	no	no	yes	M	U	U	M	U	U	U	U	U	M	M
polypropylene	translucent/transparent	no	no*	yes	S	S	S	M	S	M	S	M	M	M	S
polyethylene	transparent/translucent	yes	no	yes	S	S	S	S	S	S	U	M	M	M	S
cellulose propionate	transparent	no	no*	no	S	U	U	U	U	M	S	S	U	M	S
stainless steel	opaque	no	no	yes	S	U	S	S	M	S	S	S	M	S	M

S = satisfactory resistance M = marginal resistance U = unsatisfactory resistance

*Polyallomer, polypropylene, and cellulose propionate tubes with diameters of 5 to 13 mm may be sliced using the Centritube Slicer (part number 347960) and appropriate adapter plate.

NOTE

This information has been consolidated from a number of sources and is provided *only* as a guide to the selection of tube or bottle materials. Soak tests at 1 g (at 20°C) established the data for most of the materials; reactions may vary under the stress of centrifugation, or with extended contact or temperature variations. To prevent failure and loss of valuable sample, **ALWAYS TEST SOLUTIONS UNDER OPERATING CONDITIONS BEFORE USE.**

WARNING

Do not use flammable substances in or near operating centrifuges.

LABWARE MATERIAL COMPATIBILITY WITH SOLVENTS AND SAMPLE

The chemical compatibility of tube or bottle materials with the gradient-forming medium or other chemicals in the solution is an important consideration. Although neutral sucrose and salt solutions cause no problems, alkaline solutions cannot be used in Ultra-Clear tubes or in polycarbonate tubes and bottles. Polycarbonate and Ultra-Clear tubes are incompatible with DMSO, sometimes used in the preparation of sucrose gradients for sedimentation of denatured DNA.

GRADIENT FORMATION AND FRACTIONATION

Consideration should be given to gradient formation and fractionation when choosing a tube for a density gradient run. If the bands or zones formed during centrifugation are indistinct, they may not be visible through a translucent material such as polyallomer. If optimum band visualization is important, Ultra-Clear, polycarbonate, or cellulose propionate tubes should be used. Whenever collection of bands or zones must be done by slicing or puncturing the tube, a thin, flexible tube wall is required. Ultra-Clear or polyallomer tubes should be used in these cases, depending on the need for transparency.

LABWARE TYPES

NOTE

Tubes made of cellulose nitrate were formerly used for various separations, particularly rate-zonal separations. Beckman Coulter discontinued the use of cellulose nitrate for tube manufacture in 1980, due to inconsistent physical properties inherent in the material. If you currently have cellulose nitrate tubes, dispose of them. Consult your laboratory safety officer for proper disposal procedures.

POLYALLOMER TUBES

Polyallomer is a copolymer of ethylene and propylene. Polyallomer tubes are translucent or transparent in appearance, depending on wall thickness, and are nonwettable (although some polyallomer tubes can be chemically treated to make them wettable). Polyallomer tubes have good tolerance to all gradient media, including alkalines. They perform well with most acids, many bases, many alcohols, DMSO, and some organic solvents. Several types of polyallomer tubes are available.

Open-Top Polyallomer Tubes



Thinwall open-top tubes (sometimes referred to as straight-wall tubes) are used in swinging bucket and fixed angle rotors. In swinging bucket rotors, thinwall tubes should be filled to within 2 or 3 mm of the tube top for proper tube support. Caps are usually required in fixed angle rotors. Thinwall tubes are designed for one-time use and should be discarded after use.



Thickwall open-top tubes offer the convenience of centrifuging partially filled tubes without tube caps in fixed angle and swinging bucket rotors. Because the solution reorients during centrifugation, the maximum partial fill volume depends on the tube angle. For greater fill volumes, use tubes with caps. Refer to the applicable rotor manual for fill volumes and speed reduction requirements. Thickwall tubes are reusable.

OptiSeal Tubes

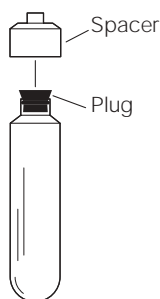

OptiSeal tubes, single-use tubes designed for use in certain rotors, are available in dome-top and bell-top styles. These tubes, which come with plastic sealing plugs, can be quickly and easily prepared for use without tools or heat. Spacers are used to seal the tubes and to support the tops of the tubes during centrifugation. With the tube plug and spacer (and rotor plug, if required) in place, the g forces during centrifugation ensure a tight, reliable seal that protects your samples. For a detailed discussion on the use of OptiSeal tubes, refer to *Using OptiSeal Tubes* (publication IN-189), included with each box of tubes.

Quick-Seal® Polyallomer Tubes

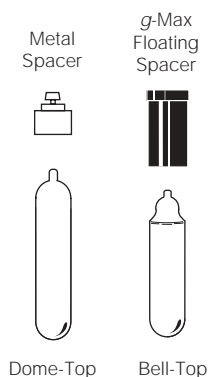

Heat-sealed Quick-Seal tubes are used in swinging bucket, vertical tube, near vertical tube, and in most fixed angle rotors. Single-use Quick-Seal tubes are a convenient form of sealable tube; they are especially useful for the containment of radioactive or pathogenic samples. There are two Quick-Seal tube designs, dome-top and bell-top.

- The bell-top simplifies removal of materials that float during centrifugation.
- Dome-top tubes hold more volume than their bell-top equivalents.

Detailed information about Quick-Seal tubes is contained in publication IN-181.

POLYCARBONATE TUBES



Polycarbonate is tough, rigid, nonwetable, and glass-like in appearance. Polycarbonate tubes are used with or without caps in fixed angle rotors, and at least half full in swinging bucket rotors. Speed reduction may be required in some rotors if the tubes are not completely filled.

Although polycarbonate tubes may be autoclaved, doing so greatly reduces the usable life of these tubes. Cold sterilization methods are recommended. Washing with alkaline detergents can cause failure. Cracking—the appearance of fine cracks in the tube—is the result of stress “relaxation” and can affect tube performance. These cracks will gradually increase in size and depth, becoming more visible. Tubes should be discarded before cracks become large enough for fluid to escape. These tubes have good tolerance to all gradient media except alkalines (pH greater than 8). They are satisfactory for some weak acids, but are unsatisfactory for all bases, alcohol, and other organic solvents.

POLYPROPYLENE TUBES

Polypropylene tubes are translucent and are reusable unless deformed during centrifugation or autoclaving. These tubes have good tolerance to gradient media including alkalines. They are satisfactory for many

acids, bases, and alcohols, but are marginal to unsatisfactory for most organic solvents. They can be used with or without caps in fixed angle rotors. Speed reduction is sometimes required with these tubes if run with less than full volume (refer to your rotor manual).

POLYETHYLENE TUBES

Polyethylene tubes are translucent or transparent and have a good tolerance for use with strong acids and bases. They are reusable but cannot be autoclaved. In swinging bucket rotors, they are used without caps, and with or without caps in fixed angle rotors.

ULTRA-CLEAR TUBES

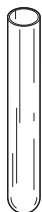

Ultra-Clear tubes, made of a tough thermoplastic, are thinwall and not wettable (but can be made wettable; see Section 3). Ultra-Clear tubes are available in two types—open-top and Quick-Seal. They are transparent centrifuge tubes, offering easy location of visible banded samples. Standard straight-wall Ultra-Clear tubes must be filled completely and capped for use in fixed angle rotors.

Ultra-Clear tubes are designed to be used one time only. These tubes have good resistance to most weak acids and some weak bases, but are unsatisfactory for DMSO and most organic solvents, including all alcohols. Ultra-Clear tubes should not be autoclaved.

CELLULOSE PROPIONATE TUBES

Cellulose propionate tubes, used in some fixed angle rotors, are transparent and designed for one-time use. They are used without caps and should be full for centrifuging. They should not be autoclaved or sterilized with alcohol. These tubes have good tolerance to all gradient media including alkalines. They are unsatisfactory for most acids and alcohols.

STAINLESS STEEL TUBES



Stainless steel tubes offer excellent resistance to organic solvents and heat, but should not be used with most acids or bases. They offer only marginal resistance to most gradient-forming materials other than sucrose and glycerol. Stainless steel tubes are very strong and can be centrifuged when filled to any level. Because of their weight, however, run speeds must often be reduced (see publication L5-TB-072). Stainless steel tubes can be used indefinitely if they are undamaged and not allowed to corrode. They may be autoclaved after use as long as they are thoroughly dried before storage.

kONICAL™ TUBES

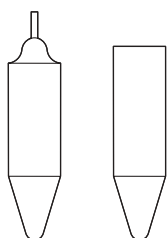

kONICAL tubes, used with conical adapters in swinging bucket rotors to optimize pelleting separations, have a conical tip that concentrates the pellet in the narrow end of the tube. The narrow bottom also reduces the tube's nominal volume and minimizes the amount of gradient material needed when pelleting through a dense cushion. They are available in polyallomer and Ultra-Clear. The kONICAL tubes come in both open-top and Quick-Seal tube designs. The Quick-Seal type have bell-shaped tops to fit the floating spacers in the g-Max system for smaller volume runs with faster pelleting.

BOTTLES



Bottles are available in polycarbonate (hard and clear), polypropylene (translucent), and polyallomer (translucent).

- Threaded-top *polycarbonate bottles* are available for many fixed angle rotors. They have a liquid-tight cap assembly and are easy to use. Caps (and plugs, if applicable) should always be removed before autoclaving.
- Type 16 and Type 28 rotors (no longer manufactured) use capped *polypropylene bottles* in addition to polycarbonate bottles.
- The Type 19 rotor uses a *polyallomer bottle* with a three-piece cap assembly consisting of a Noryl plug, a neoprene O-ring, and a Delrin cap.

Information about these bottles can be found in the individual rotor manuals.

TEMPERATURE LIMITS

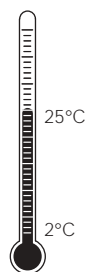

Each labware material has a specified temperature range. Although some high-speed centrifuges can achieve temperatures as high as 45°C, only certain tube or bottle materials can be run under these conditions. Most containers are made of thermoplastic materials that soften at elevated temperatures. This temperature-induced softening, together with such factors as the centrifugal force, the run duration, the type of rotor, previous run history, and the tube angle, can cause labware to collapse. Therefore, if high-temperature runs—above 25°C—are required, it is best to pretest labware under the actual experimental conditions, using buffer or gradient of similar density rather than a valuable sample. (Stainless steel tubes can be centrifuged at any temperature.)

- Plastic labware has been centrifuge tested for use at temperatures between 2 and 25°C. For centrifugation at other temperatures, pretest tubes under anticipated run conditions.
- If plastic containers are frozen before use, make sure that they are thawed to at least 2°C prior to centrifugation.

SPACERS AND FLOATING SPACERS

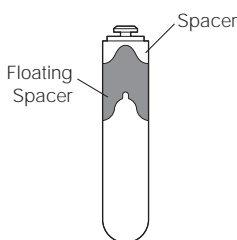









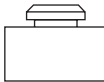

- OptiSeal tubes *must be used with the appropriate spacer* to seal properly. (OptiSeal spacers are listed in Table 3-2.)
- Quick-Seal tubes use a spacer (Table 2-2), one or more floating spacers, or a combination of both (depending on the size of the tube) to support the top of the tube during centrifugation. The particular combination depends on the type of rotor being used. In swinging bucket and fixed angle rotors, the top of the tube must be supported. In near vertical tube and vertical tube rotors, the entire tube cavity must be filled.

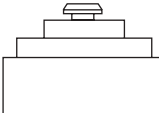
The *g*-Max system uses a combination of short bell-top Quick-Seal tubes and floating spacers (also referred to as *g*-Max spacers). The floating spacers sit on top of the Quick-Seal tubes so there is no reduction of maximum radial distance, and therefore, no reduction of *g* force. The shorter pathlength of the tubes also permits shorter run times. For more information on the *g*-Max system, see publication DS-709.

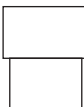
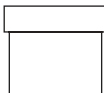
Plastic spacers have been tested for centrifugation between 2 and 25°C. If spacers are centrifuged at temperatures significantly greater than 25°C, deformation of the spacer and tube may occur.

Table 2-2. Quick-Seal Tube Spacers

Part Number	Spacer Description	
342883	black-anodized aluminum	
342418	clear-anodized aluminum	
342696	clear-anodized aluminum	
342695	red-anodized aluminum	
342699	red-anodized aluminum	
342417	clear-anodized aluminum	
342697	titanium	
344389	white Delrin	
344634 344635	white Delrin	
344676	black Noryl	
345828	black Noryl	
349289	blue-anodized aluminum	
358164	black Delrin	

ADAPTERS

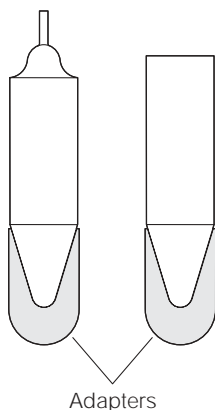

Many rotors can accommodate a variety of tube sizes by using adapters that line the tube cavity or bucket.

- Small, open-top tubes use Delrin² adapters, which line the tube cavity or bucket.
- Adapters with conical cavities must be used to support both open-top and Quick-Seal konical tubes.

Tubes used with adapters can be filled (and capped) according to the type of tube and the design of the rotor being used. Many of the small, straightwall tubes, when used with adapters, require speed reductions due to the added density of Delrin (1.4 g/mL). Additional speed reductions for heavy tube loads may also be required (refer to ALLOWABLE RUN SPEEDS in Section 1). In vertical tube rotors, r_{\min} is unchanged (see the illustration in Figure 1-2). However, in fixed angle and near vertical tube rotors, r'_{\min} must be calculated:

$$r'_{\min} = r_{\max} - \frac{d}{2} (1 - \sin \theta + \cos \theta) - L \sin \theta \quad (9)$$

where

r_{\max} = the distance in millimeters from the axis of rotation to the farthest part of the tube cavity,

d = diameter of the tube in millimeters,

L = length of the tube in millimeters, and

θ = tube angle of the rotor being used.

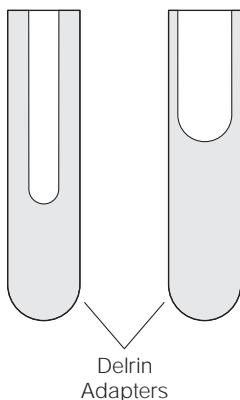

A Delrin adapter in a rotor cavity or bucket will significantly change the radial distances measured in the tube. The equations below can be used to determine r'_{\max} and r'_{\min} for a given rotor with a Delrin adapter. Table 2-3 lists adapter dimensions used in the equations.

$$r'_{\max} = r_{\max} - \left(\frac{d_1 - d_2}{2} \right) - \left(t - \frac{d_1 - d_2}{2} \right) \sin \theta \quad (10)$$

$$r'_{\min} = r_{\max} - \frac{d_1}{2} - \left(t - \frac{d_1}{2} + L \right) \sin \theta - \frac{d_2}{2} \cos \theta \quad (11)$$

² Delrin is a registered trademark of E. I. Du Pont de Nemours & Company.

where

r_{\max} = the distance in millimeters from the axis of rotation to the farthest part of the tube cavity,

d_1 = outside diameter of the adapter,

d_2 = inside diameter of the adapter,

L = adapter cavity length,

t = thickness of the adapter bottom, and

θ = tube angle of the rotor being used.

The values of r'_{\max} and r'_{\min} can be used to calculate the k factor and the relative centrifugal field when adapters are used (see the equations in the Glossary in Appendix E).

Table 2-3. Dimensions of Delrin Adapters. Use these values to calculate radial distances for tubes in Delrin adapters.

Delrin Adapter		Dimensions (mm)			
Tube Size (mL)	Part Number	d_1	d_2	L	t
0.8	305527	13.08	5.49	42.09	3.99
	356860	18.08	5.36	43.51	3.99
2	303376	16.23	8.66	46.25	6.93
	303823	13.08	8.66	46.25	6.93
	303699	13.08	8.66	46.25	33.91
3	303401	16.23	13.34	26.97	44.73
	303956	16.23	13.34	26.97	31.50
3.5	350781	38.25	11.10	71.12	14.30
4	303402	16.23	13.34	36.50	35.20
	303957	16.23	13.34	35.50	22.23
6.5	303313	16.23	13.34	58.72	12.98
	303392	25.65	13.34	58.72	25.40
	303449	38.23	13.34	58.72	37.31
	303687	25.65	13.34	69.85	11.13
10.5	303459	38.23	13.34	84.12	11.91
13.5	303307	25.65	16.51	71.42	12.70
	303448	38.23	16.51	71.42	24.61



Using Tubes, Bottles, and Accessories

This section contains general instructions for filling and capping the labware used in Beckman Coulter preparative rotors, for selecting and using the appropriate accessories, and for recovering samples after a run. Individual rotor manuals provide specific instructions on tubes, bottles, and accessories that can be used in a particular rotor.¹

Rotor use instructions are in Section 4 for fixed angle rotors, in Section 5 for swinging bucket rotors, and in Section 6 for vertical tube and near vertical tube rotors. A table of chemical resistances is in Appendix A of this manual. Reference information on some commonly used gradient materials is in Appendix D.

GRADIENT PREPARATION

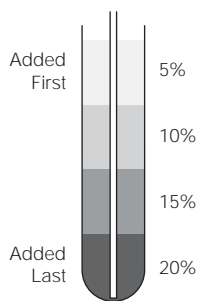

Many commercial gradient formers are available. These devices usually load a tube by allowing the gradient solutions to run down the side of the tube. The heaviest concentration is loaded first, followed by successively lighter concentrations. This method is acceptable for wettable tubes; however, loading a nonwetable tube (such as Ultra-Clear, polyallomer,² and polycarbonate) by allowing solutions to run down the side of the tube can cause mixing.

Gradients in nonwetable tubes can be prepared using a gradient former by placing a long syringe needle or tubing to the tube bottom and reversing the gradient chambers. In that way the lightest gradient concentration is loaded first, underlayered by increasingly heavier concentrations.

¹ A complete list of tubes, bottles, and adapters is provided in the latest edition of the Beckman Coulter *Ultracentrifuge Rotors, Tubes & Accessories* catalog (BR-8101), available at www.beckmancoulter.com.

² It has been reported, however, that polyallomer tubes have been made wettable by soaking them in a chromic acid bath for about 30 minutes (see *Preparation of Polyallomer Centrifuge Tubes for Density Gradients*, Anal. Biochem. 32:334-339. H. Wallace, 1969). Also, a method of making Ultra-Clear tubes wettable that has proven successful for some users is described at the end of this section.

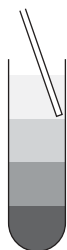

You can also prepare preformed step gradients by hand, using a pipette. Carefully layer solutions of decreasing concentration by placing the tip of the pipette at the angle formed by the tube wall and the meniscus, or float the lighter gradient concentrations up by adding increased density solutions to the tube bottom using a hypodermic syringe with a long needle such as a pipetting needle.

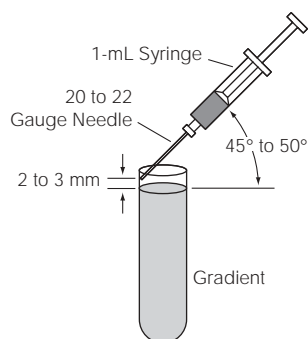

Another way to form a linear gradient is to allow a step gradient to diffuse to linearity. Depending on the concentration differential between steps and the cross-sectional area, allow 3 to 6 hours for diffusion at room temperature, and about 16 hours at 0 to 4°C. For diffusion of step gradient in Quick-Seal and capped straightwall tubes, slowly lay the tube on its side (tube contents will not spill, but make sure the tube does not roll). After 2 hours at room temperature, slowly set the tube upright.

Once the gradient is prepared, layer the sample on top of the gradient.

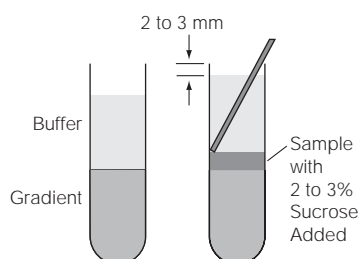

For *thinwall* tubes only partially filled with gradient, add a buffer solution to fill the tube to provide tube wall support. Although the gradient volume is reduced, sample volume is not changed.

NOTE

If a partially filled *thickwall* tube is centrifuged, the tube does not require liquid support, and therefore, the buffer solution is not required.

CESIUM CHLORIDE GRADIENTS

Cesium chloride gradients can be made by filling the tube with a homogeneous solution of CsCl and sample. Select a homogeneous CsCl solution density so that when it is distributed, its density range will encompass the density of the particle(s) of interest. Refer to Appendix C for an explanation of the use of the CsCl curves.

GENERAL FILLING AND SEALING OR CAPPING REQUIREMENTS

See Table 3-1 for general filling and sealing or capping requirements for tubes and bottles used in preparative rotors. Maximum fill volume includes sample and gradient. Refer to individual rotor manuals for specific filling and capping requirements.



WARNING

Handle body fluids with care because they can transmit disease. No known test offers complete assurance that they are free of micro-organisms. Some of the most virulent—Hepatitis (B and C) and HIV (I–V) viruses, atypical mycobacteria, and certain systemic fungi—further emphasize the need for aerosol protection. Handle other infectious samples according to good laboratory procedures and methods to prevent spread of disease. Because spills may generate aerosols, observe proper safety precautions for aerosol containment. Do not run toxic, pathogenic, or radioactive materials in these rotors without taking appropriate safety precautions. Biosafe containment should be used when Risk Group II materials (as identified in the World Health Organization *Laboratory Biosafety Manual*) are handled; materials of a higher group require more than one level of protection.

FILLING AND PLUGGING OptiSeal TUBES

OptiSeal tubes are not sealed prior to centrifugation; a Noryl plug, furnished with each tube, is inserted into the stem of filled tubes. When the tubes are loaded into the rotor with tube spacers (and rotor plugs, in vertical tube and near vertical tube rotors) in place, the *g*-force during centrifugation ensures a tight, reliable seal that protects your samples. For a detailed discussion on the use of OptiSeal tubes, refer to *Using OptiSeal Tubes* (publication IN-189).

Table 3-1. Filling and Capping Requirements for Tubes and Bottles

Tube or Bottle	Filling Level Requirements		
	Swinging Bucket Rotors	Fixed Angle Rotors	Vertical and Near Vertical Tube Rotors
Polyallomer			
thinwall tubes	within 2–3 mm of top	full with cap	—
thickwall tubes	at least 1/2 full	1/2 full to max capless level or full with cap (Table 3-3)	—
OptiSeal tubes	full and plugged	full and plugged	full and plugged
Quick-Seal tubes	full and heat sealed	full and heat sealed	full and heat sealed
konical Quick-Seal tubes	full and heat sealed	—	—
konical open-top tubes	within 2–3 mm of top	—	—
bottles	—	min to max with screw-on cap or cap assembly (Table 3-3)	—
Ultra-Clear			
open-top tubes	within 2–3 mm of top	full with cap	—
Quick-Seal tubes	—	full and heat sealed	full and heat sealed
Polycarbonate			
thickwall tubes	at least 1/2 full	1/2 full to max capless level or full with cap or cap assembly (Table 3-3)	—
thickwall bottles	—	min to max with screw-on cap or cap assembly (Table 3-3)	—
Stainless Steel			
tubes	any level	any level with cap or cap assembly (Table 3-3)	—
Cellulose Propionate			
tubes	full	1/2 to max capless level; no cap	—
Polypropylene			
tubes and bottles	at least 1/2 full	1/2 to max capless level or full with cap or cap assembly	—
Polyethylene			
tubes	at least 1/2 full	1/2 to max capless level or full with cap	—
Corex/Pyrex			
tubes and bottles	at least 1/2 full	1/2 to max capless	—

FILLING THE TUBES

For filling convenience, use the appropriate eight-tube rack listed in Table 3-2.

1. Use a pipette or syringe to fill each tube, leaving *no* fluid in the stem (see Figure 3-1). Overfilling the tube can cause overflow when the plug is inserted; however, too much air can cause the tube to deform and disrupt gradients and sample bands, as well as increasing the force required to remove the tube from the cavity after centrifugation.

NOTE

If air bubbles occur in the tube shoulder area, tilt and rotate the tube before it is completely filled to wet the tube.

Homogeneous solutions of gradients and sample may be loaded into the tubes and centrifuged immediately. (See GRADIENT PREPARATION above.) If the sample is to be layered on top, be sure to allow enough room for the sample so that there is *no fluid in the tube stem*.

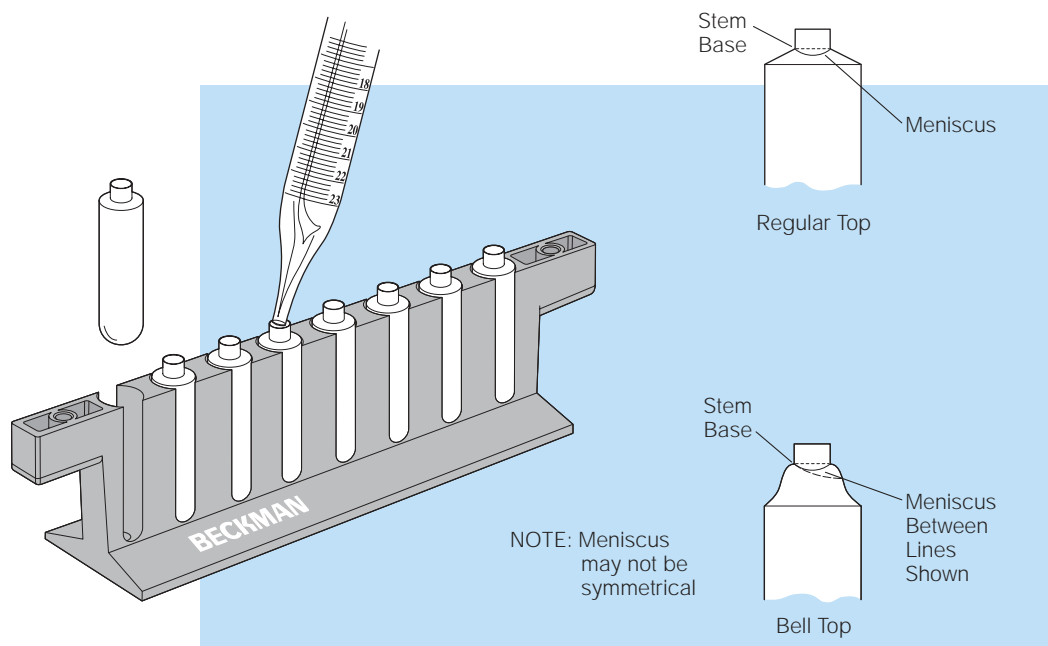











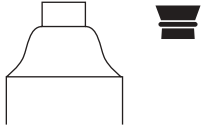

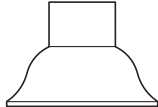
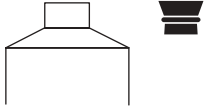
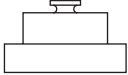

Figure 3-1. Filling OptiSeal Tubes. Stems are large enough to accept standard pipettes.

Table 3-2. OptiSeal Tubes and Accessories.
Spacers are shown in the correct orientation for placement onto tubes.

Size (mm)	Volume (mL)	Part Number* (pkg/56)	Spacer	Rack Assembly	Rotor
13 × 33	3.3	361627 	361678 (pkg/2) amber Ultem† 	361650	SW 55 Ti, SW 50.1
13 × 48	4.7	361621 Bell-top 	361676 (pkg/2) amber Ultem 	361638	Type 50.4 Ti, Type 50.3 Ti
13 × 51	4.9		362198 gold aluminum 	361638	VTi 90, VTi 80, VTi 65.2, NVT 90, NVT 65.2
			362199 black Noryl 	361638	VTi 65
16 × 60	8.9	361623 Bell-top 	361670 (pkg/2) amber Ultem 	361642	Type 90 Ti, Type 80 Ti, Type 70.1 Ti, Type 65, Type 50 Ti, Type 50
16 × 70	11.2	362181 	362202 gold aluminum 	360538	NVT 65, VTi 65.1
25 × 77	32.4		361669 (pkg/2) amber Ultem 	361646	Type 70 Ti, Type 60 Ti, Type 55.2 Ti, Type 50.2 Ti, Type 42.1, Type 30
			392833 (pkg/2) amber Ultem 	361646	SW 32 Ti SW 28
25 × 89	36.2	362183 	362204 gold aluminum 	360542	VTi 50, VAC 50, VC 53

* Disposable plastic plugs included.

† Ultem is a registered trademark of GE Plastics.

2. After filling the tube, make sure that there is no fluid in the stem. (Draw off excess fluid with a syringe or pipette. If necessary, wipe the inside of the stem with a lintless tissue.)
3. Fill the remaining tubes in the same manner.

SEATING THE TUBE PLUGS

Eight tubes can be prepared for use at once in the specially designed racks listed in Table 3-2.

NOTE

The Ultem spacers (361678) snap onto the 3.3-mL tubes (361627). To avoid disturbing the sample or splashing out liquid, put the spacers on these tubes *before* inserting the plugs.

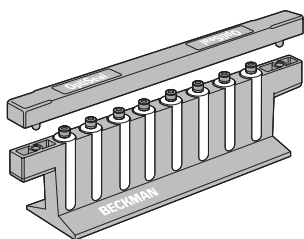
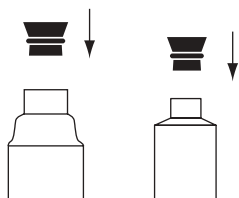

1. Make sure that no fluid is in the tube stem and that the stem is clean and dry.
2. Insert a Noryl plug assembly (plug and O-ring—shipped assembled) in each tube stem.
3. Set the plug seating bar on the rack, ensuring that the pegs at each end fit into the rack openings.
4. Press firmly straight down all along the top of the bar. When you remove the bar, the plugs should be straight and seated into the stems.
5. Check the tubes to be sure all plugs are seated. If any plugs are not seated, seat them individually.

FILLING AND SEALING QUICK-SEAL TUBES

Fill each tube to the base of the neck, using a syringe with a 13-gauge or smaller needle.³ A small air space (no larger than 3 mm) may be left, but an air bubble that is too large can cause the tube to deform, disrupting gradients or sample. Spacer and/or floating spacer requirements for Quick-Seal tubes are described in the individual rotor manuals. The neck of the tube should be clean and dry before sealing.

There are two tube sealers for use with Quick-Seal tubes—the hand-held Cordless Tube Topper™, and the older tabletop model (no longer available). Refer to *How to Use Quick-Seal® Tubes with the Beckman Cordless Tube Topper™* (publication IN-181) for detailed information about the Tube Topper. Instructions for using the older tabletop tube sealer are in *How to Use Quick-Seal® Tubes with the Beckman Tube Sealer* (publication IN-163).

Quick-Seal tubes are heat-sealed quickly and easily using the Beckman Cordless Tube Topper (see Figure 3-2). The following procedures provide the two methods for heat-sealing Quick-Seal tubes using the hand-held Tube Topper. Use the applicable tube rack listed in the appropriate rotor manual.

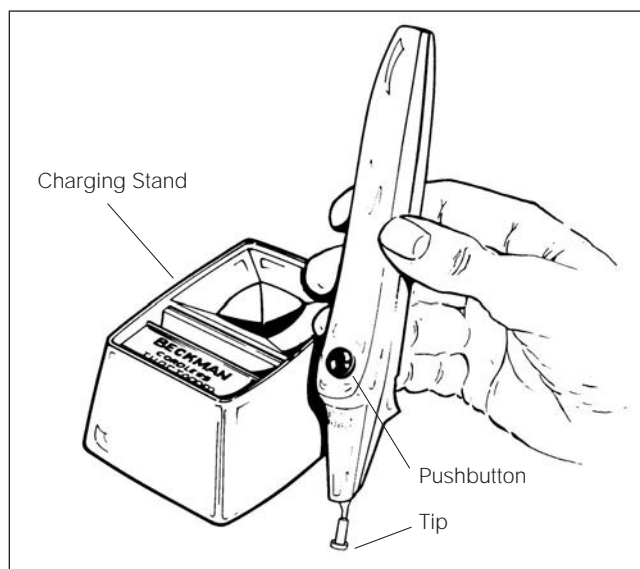

Figure 3-2. The Cordless Quick-Seal Tube Topper

³ A sample application block (342694) is available for holding and compressing tubes, and can be used to layer samples on preformed gradients in polyallomer Quick-Seal tubes.

**CAUTION**

Before plugging in the Tube Topper, be sure that you have a proper power source (120 V, 50 or 60 Hz). Charge your Cordless Tube Topper only in the charging stand supplied with it.

1. Remove the Tube Topper from the charging stand. Leave the pushbutton turned to LOCK position.

**WARNING**

Touching the heated tip of the Tube Topper will cause burns. When the pushbutton is pressed, the tip heats almost immediately. Make sure the pushbutton is turned to LOCK position unless you are actually sealing a tube.

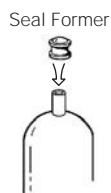

2. Place a seal former on each tube stem. (The Teflon⁴ coating on the seal formers is permanent. Do not scratch the interior of the formers, as you may damage this coating.)
3. Seal each tube using Method A or B. *Method A is preferable when sealing smaller tubes or when resealing a tube that leaks.*

**CAUTION**

Always keep the Tube Topper in its charging stand when not in use. Do not lay the unit against any surface after use until the tip has cooled (3 to 5 minutes after shut off).

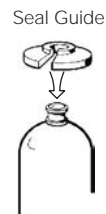
METHOD A — WITH THE SEAL GUIDE

- a. Place a seal guide (with the flat side down) over the seal former.
- b. Turn the Tube Topper pushbutton to USE position. Press the pushbutton and wait 3 to 5 seconds for the tip to heat.

⁴ Teflon is a registered trademark of E.I. Du Pont de Nemours & Co.

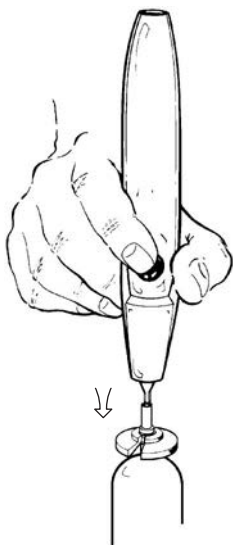

- c. Apply the tip of the Tube Topper vertically to the seal former. Press down gently for about 10 seconds. The seal guide should move down the tube stem until it rests on the tube shoulder. Using the seal guide prevents the seal former from being pressed into the tube shoulder.

NOTE

Always apply the tip of the Tube Topper vertically to the seal former. Apply gentle pressure when sealing the tube.

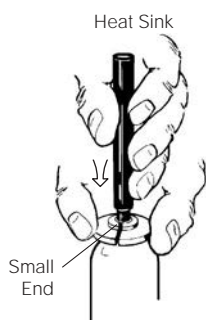

- d. When the seal guide has moved to the correct position, remove the Tube Topper and pinch the circular seal guide to hold the seal former in place.
- e. Place the heat sink (small end) over the cap for 2 to 3 seconds while the plastic cools—do NOT let the seal former pop up. (If the seal former does pop up, the tube may not have an adequate seal and may need to be resealed.)

Removal Tool

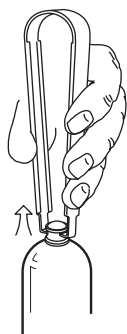

- f. Remove the heat sink and seal guide. When the seal former cools, remove it by hand or with the removal tool (361668). Save the seal guide and former for future use.

METHOD B — WITHOUT THE SEAL GUIDE

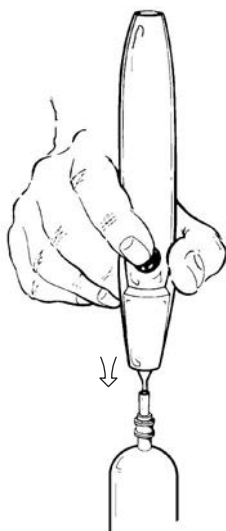

NOTE

Always apply the tip of the Tube Topper vertically to the seal former. Apply gentle pressure when sealing the tube.

- a. Turn the Tube Topper pushbutton to USE position. Press the pushbutton and wait 3 to 5 seconds for the tip to heat.
- b. Apply the tip of the Tube Topper vertically to the seal former. The seal former should move down the tube stem until it just rests on the tube shoulder. Be careful NOT to press the seal former into the tube shoulder; it may cause the tube to leak.

NOTE

It is very important to apply the heat sink immediately. To do so, we recommend that you have it in one hand, ready to apply as soon as needed.

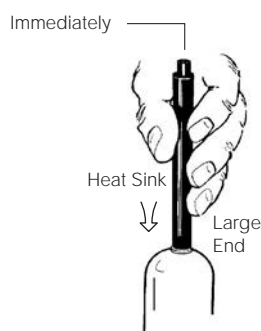

- c. Remove the Tube Topper. IMMEDIATELY place the large end of the heat sink over the seal former. Hold it there for a few seconds while the plastic cools—do NOT let the seal former pop up. (If the seal former does pop up, the tube may not have an adequate seal and may need to be resealed.)
 - d. Remove the heat sink. When the seal former cools, remove it by hand or with the removal tool (361668).
4. After completing either heat-sealing method, squeeze the tube gently (if the tube contents may be disturbed) to test the seal for leaks. If the tube does leak, try resealing it using Method A.
 5. The tube is now ready for centrifugation. Seal the remaining tubes.
 6. Return the Tube Topper to its charging stand when finished.

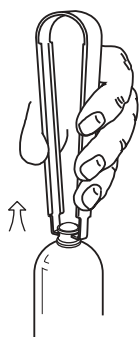

FILLING OPEN-TOP TUBES

OPEN-TOP POLYALLOMER TUBES

Open-top polyallomer tubes are used in swinging bucket and fixed angle rotors.

Swinging Bucket Rotors

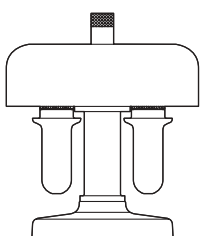

Fill all opposing tubes to the same level.

- *Thinwall Tubes*—Fill to within 2 or 3 mm of the top for proper tube wall support.
- *Thickwall Tubes*—Fill at least half full.

Fixed Angle Rotors

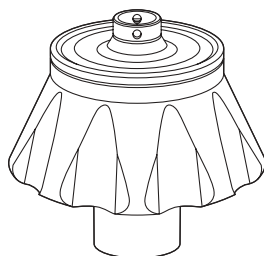

Fill all opposing tubes to the same level.

- *Thinwall Tubes*—Must be completely filled; liquid and cap for support of the tube wall is critical.
- *Thickwall Tubes*—Can be partially filled and centrifuged as indicated in the applicable rotor manual. Speed reductions may be required for these partially filled tubes. For greater fill volumes and faster speeds, tube caps should be used. Refer to the applicable rotor manual for fill volumes and speed limitations.

OTHER OPEN-TOP TUBES

Open-top tubes of other materials can also be used in fixed angle and swinging bucket rotors. (Vertical tube and near vertical tube rotors use only OptiSeal or Quick-Seal tubes.) Fill these tubes as indicated below.

Polycarbonate

Thickwall polycarbonate tubes can be centrifuged partially filled. Observe maximum rotor speeds and fill volumes listed in the applicable rotor manual.

UltraClear

Fill all opposing tubes to the same level.

- For *swinging bucket* rotors, fill to within 2 or 3 mm of the top of the tube.
- Fill thickwall polypropylene tubes at least half full to maximum level in *fixed angle* rotors. Speed reduction is required. Refer to the applicable rotor manual.

Polypropylene

Fill all opposing tubes to the same level.

- For *swinging bucket* rotors, fill to within 2 or 3 mm of the top of the tube.
- Fill thickwall polypropylene tubes at least half full to maximum level in *fixed angle* rotors. Speed reduction is required. Refer to the applicable rotor manual.

Polyethylene

For *swinging bucket* and *fixed angle* rotors, fill these tubes from half full to maximum level. Refer to the applicable rotor manual.

Stainless Steel

Because of their strength, stainless steel tubes can be centrifuged while filled to any level (with all opposing tubes filled to the same level). However, run speeds must be reduced due to their weight. The criteria for speed reduction depends on the tube-cap material and the strength of the rotor being used. Refer to the applicable rotor manual or *Run Speeds for Stainless Steel Tubes* (publication L5-TB-072) for correct run speeds.

CAPPING TUBES

Caps must be used with thinwall polyallomer and Ultra-Clear tubes in fixed angle rotors. To prevent spillage, thickwall polyallomer, polycarbonate, and stainless steel tubes must be capped when fill levels exceed the maximum level for uncapped tubes as listed in the applicable rotor manual.

Cap requirements depend on the tube or bottle material, diameter, and wall thickness, as well as on the rotor. The applicable rotor instruction manual specifies which cap should be used with a particular tube or bottle.

TUBE CAP ASSEMBLIES

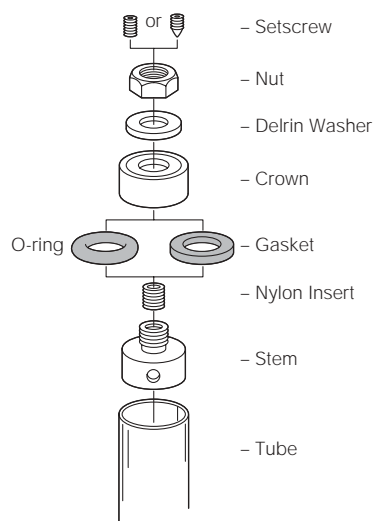

A tube-cap assembly includes

- a stem,
- a nylon insert,
- an O-ring or flat gasket,
- a crown,
- a Delrin crown washer (in red, blue, and black aluminum caps),
- a hex-shaped nut, and
- a stainless steel setscrew.

The stem supports the upper portion of the tube. To provide tube support during centrifugation, the stem is longer for thinwall tubes than for thickwall or metal tubes. Some stems have an abraded

surface to increase friction between the O-ring and the stem, minimizing rotation of the stem when the cap nut is tightened. The O-ring or gasket seals the cap-to-tube interface.

The crown seats on the rotor tube cavity counterbore and supports the stem and the nut during centrifugation. In some high-performance rotors, tube caps have crown washers. The washer minimizes friction, which would reduce the effective tightening of the cap nut, and also protects the nut and the crown. After the tube has been capped, tightened, and filled, the setscrew is used to seal the filling hole in the stem by seating against the nylon insert.

Refer to Table 3-3 for detailed information about tube caps.

**CAUTION**

Do not interchange tube caps or tube-cap components, even if they appear to be the same. Tube caps are designed specifically for a particular tube in a particular rotor. Cap stems and crowns are often machined differently for each type of rotor to ensure proper sealing and support and to withstand stresses experienced during centrifugation. The uneven weight difference between an O-ring cap and a comparable flat-gasket cap (as much as 0.7 gram) could damage the rotor. Store tube caps assembled, dry, and classified according to the tube and rotor for which they are designed.

Titanium Caps

High-strength titanium cap assemblies for thinwall Ultra-Clear and polyallomer tubes are required for maximum rotor speeds in the Type 90 Ti, 80 Ti, 75 Ti, and 70.1 Ti rotors. Titanium caps can be identified by the darker gray, shiny metal. The cap crown is specially machined to lock onto the cap stem. To ensure proper compression of the O-ring, these caps must be tightened with a torque wrench while the capped tube is held in the tube-cap vise.

A special crimp-lock cap assembly is required to provide the reliable seal necessary for maximum rotor speed in the Type 70.1 Ti rotor. The 25 × 83-mm thinwall polyallomer tube is crimped between the titanium crown and the aluminum stem. Instructions for assembling the tube and cap are in the Type 70 Ti rotor instruction manual. A special tool kit (338841) is required.

Table 3-3. Tube Cap Assemblies for Open-Top Tubes in Fixed Angle Rotors. (Tube caps are not available for thickwall tubes used in Types 80 Ti, 75 Ti, 70.1 Ti, 50.4 Ti, 50.3 Ti, 42.2 Ti, 40.3, and 25 rotors.)

Tube Cap Assembly ^a	Hex Nut	Crown	Setscrew	Insert	O-ring or Gasket	Stem	Tube Type	Rotor Type
8 mm (⁵ / ₁₆ in.)								
303624	303379	303809	—	—	303730	303377	UC ^b	90 Ti, 80 Ti, 75 Ti, 70.1 Ti, 65, 50 Ti, 50, 40
303658	303379	303810	—	—	303730	303377	UC	50.3 Ti
13 mm (¹ / ₂ in.)								
303113	301870	307004	—	—	344672	307005	SS	80 Ti, 75 Ti, 70.2 Ti, 70 Ti, 60 Ti, 55.2 Ti, 50.4 Ti, 50.3 Ti, 50.2 Ti, 50 Ti, 45 Ti, 42.1, 40, 35, 21
305022 ^c	301870	307004	—	—	344672	302331	SS	80 Ti, 75 Ti, 70.1 Ti, 70 Ti, 65, 60 Ti, 55.2 Ti, 50.4 Ti, 50.3 Ti, 50.2 Ti, 50 Ti, 45 Ti, 42.1, 40, 35, 21
346256	301870	307004	803543	302312	344672	346246	thinwall PA, UC, SS	90 Ti, 80 Ti, 75 Ti, 70.1 Ti, 70 Ti, 65, 60 Ti, 55.2 Ti, 50.4 Ti, 50.3 Ti, 50.2 Ti, 50 Ti, 45 Ti, 42.1, 40, 35, 21
16 mm (⁵ / ₈ in.)								
303319	301870	307006	338864	302312	301869	302266	SS	90 Ti, 70 Ti, 65, 60 Ti, 55.2 Ti, 50.2 Ti, 50 Ti, 50, 45 Ti, 42.1, 40, 35, 21
330860	301870	330774	803543	302312	858046	330788	thinwall PA, UC	70 Ti, 65, 60 Ti, 55.2 Ti, 50.2 Ti, 50 Ti, 50, 45 Ti, 42.1, 40, 35, 21
338907 ^d	301870	338911	338864	302312	878572	338910	thickwall PA, PC	90 Ti, 70 Ti, 65, 60 Ti, 55.2 Ti, 50.2 Ti, 50 Ti, 50, 45 Ti, 42.1, 40, 35, 21
341968 ^e	335320	335319	338864	302312	858046	341969	thinwall PA	90 Ti, 80 Ti, 75 Ti, 70.1 Ti
					870380	341969	UC	90 Ti, 80 Ti, 75 Ti, 70.1 Ti

— Continued

Table 3-3. Tube Cap Assemblies for Open-Top Tubes in Fixed Angle Rotors (continued)

Tube Cap Assembly ^a	Hex Nut	Crown	Setscrew	Insert	O-ring or Gasket	Stem	Tube Type	Rotor Type
25 mm (1 in.)								
302359	301870	302169	338864	302312	301473	302168	thinwall PA, UC	30
338904 ^d	330791	338912 ^f	338864	302312	878188	338908	thickwall PA, PC	30
302133	301870	302169	338864	302312	301473	302138	SS	70 Ti, 60 Ti, 55.2 Ti, 50.2 Ti, 42.1, 30
331151	330791	331153 ^f	338864	302312	334280	331152	thinwall PA, UC	70 Ti, 60 Ti, 55.2 Ti, 50.2 Ti, 42.1
338906 ^d	330791	338915 ^f	338864	302312	878188	338908	thickwall PA, PC	70 Ti, 60 Ti, 55.2 Ti, 50.2 Ti, 42.1
337927 ^g	330791	338863 ^f	338864	302312	—	338865	thinwall PA	70 Ti
38 mm (1 1/2 in.)								
326891	301870	326890	808482	302312	346242	326889	thinwall PA, UC	21
338903 ^d	330791	338914 ^f	338864	302312	341767	338909	thickwall PA, PC	21
326905	301870	326890	338864	302312	801761	326899	SS	45 Ti, 35, 21
330901	330791	330793 ^f	338864	302312	346242	330900	thinwall PA, UC	45 Ti, 35
338905 ^d	330791	338913 ^f	338864	302312	341767	338909	thickwall PA, PC	45 Ti, 35

^a Tube caps are aluminum unless otherwise noted.

^b Abbreviations: PA = polyallomer; PC = polycarbonate; SS = stainless steel; UC = UltraClear

^c Aluminum and stainless steel

^d Tube cap is optional. Use a tube cap when centrifuging a thickwall tube at its maximum fill capacity.

^e Titanium

^f Washer, part number 330899, is also required.

^g Aluminum and titanium

Aluminum Caps

Aluminum caps are anodized for corrosion resistance, with colored crowns for identification.

Red-anodized. Aluminum caps (aluminum stem and crown) with red-anodized crowns are used with thinwall Ultra-Clear and polyallomer tubes in high-performance rotors. These extra-strength caps are designed for the greater forces generated in the high-performance rotors. The cap nut should be tightened with a torque wrench while the tube is held in the tube-cap vise.

Blue-anodized. Aluminum caps with blue-anodized crowns are used with thickwall polyallomer and polycarbonate tubes for centrifugation at their maximum fill volumes in high-performance rotors. The cap nut should be tightened with a torque wrench while the tube is held in the tube-cap vise.

Clear- and black-anodized.

- Clear-anodized crown aluminum caps that use *O-rings* for sealing are used in many rotors with many types of tubes. Refer to Table 3-3. The caps should be hand tightened with a hex driver while the tube is held in the tube-cap vise (refer to ASSEMBLING TUBE CAPS, below).
- Aluminum caps that use *flat gaskets* for sealing are used with small-diameter (13-mm) thinwall Ultra-Clear and polyallomer tubes in all fixed angle rotors except Types 42.2, 25, and 19. They are also used with stainless steel tubes. Some caps for very small-diameter (less than 13-mm) tubes do not have filling holes (nylon insert or setscrew). The tube crown is made from a lighter-weight aluminum alloy than that used for other clear aluminum caps; therefore, *do not interchange cap parts or use these caps in place of O-ring caps, since the weight difference can cause rotor imbalance*. The caps should be hand tightened with a hex driver while the tube is held in the tube-cap vise.
- Caps for thickwall tubes used in Type 21 rotors have *Delrin crown washers* and must be tightened with a torque wrench.
- Caps for thickwall tubes used in Type 30 rotors have black-anodized crowns and use *neoprene O-rings* for sealing. These caps have Delrin crown washers and must be tightened with a torque wrench.

INSPECTING AND LUBRICATING TUBE CAPS

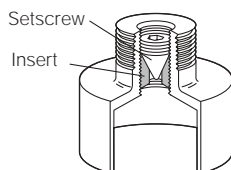
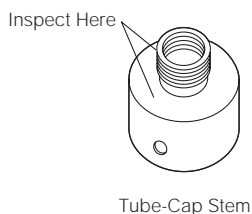
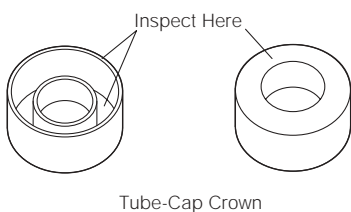

1. Inspect cap components before each use. Replace any damaged components.
 - Inspect the cap crown for stress cracking, and check the stem and nut threads for damage or signs of wear and for adequate lubrication.
 - Inspect the O-ring or gasket for cracks, nicks, or flattened areas.
 - Inspect the underside of the stem; the white nylon insert should not protrude below the filling hole.
 - If the cap assembly has a filling hole, run the setscrew in against the nylon insert, making sure the setscrew will not displace the insert.
 - Check the setscrew hex socket for damage that would prevent tightening or removal.
2. Regularly apply a thin, uniform coat of Spinkote lubricant (306812) on the stem threads.

NOTE

Keep the O-ring or flat gasket dry and free from lubricant during assembly. Wet or greased O-rings or gaskets will slip when the cap nut is tightened and the cap will not seal properly.

ASSEMBLING TUBE CAPS

See Figure 3-3 and Table 3-4 for required tools and torque requirements.



CAUTION

Do not use damaged wrenches or hex drivers, or tools that have burrs. A burred tool can score the crown, which could then fail and damage the rotor.

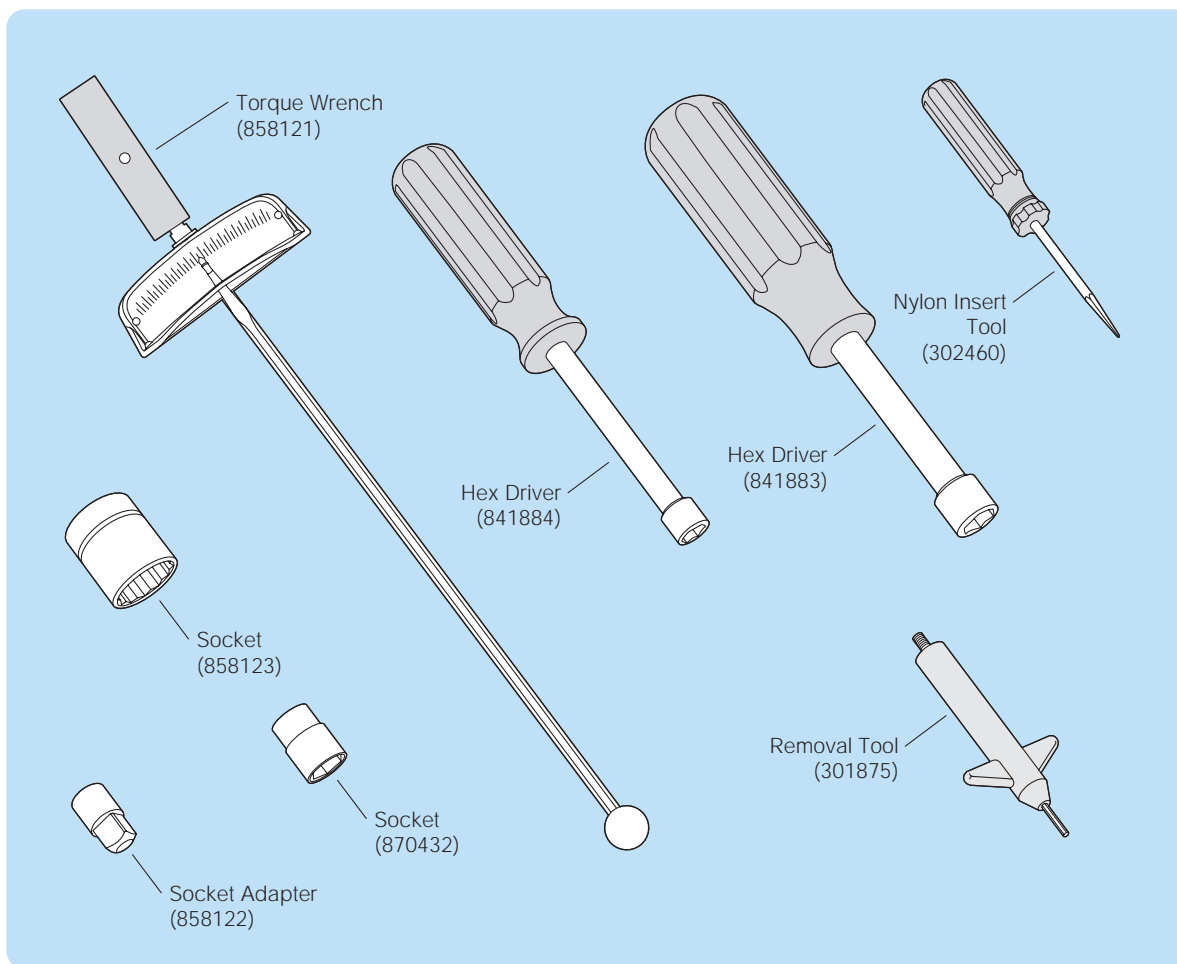
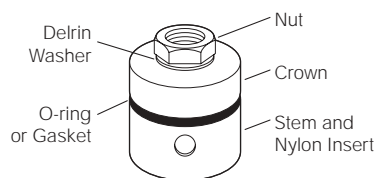

Figure 3-3. Tools Used to Assemble Tube Caps

1. If possible, fill tubes one-half to three-quarters full before capping. *Small-diameter tubes that use caps without filling holes (caps 303624, 303658, 303113, and 305022) must be completely filled before capping.*
2. *Loosely* assemble the stem, the O-ring or gasket, the crown, the crown washer (if applicable), and the nut. The nylon insert should already be installed in the stem.⁵ For titanium caps, turn the crown slightly to be sure it is properly seated on the stem.



⁵ Nylon inserts are installed in the stems of cap assemblies purchased as a unit. Stems ordered separately do not contain an insert. See Section 7 for installation.

Table 3-4. Required Tools and Torque Values

Tightening Tool	Tube Caps*	Cap Nut† Size/ Part Number	Torque Value
Torque wrench (858121) Socket (870432)	titanium cap, 341968	11 mm (⁷ / ₁₆ in.) 335320 (titanium)	10 to 11 N•m (90 to 100 in.-lb)
Torque wrench (858121) Socket (858122) Socket (858123)	331151 (red) 330901 (red) 338905 (blue) 338904 (black) 338906 (blue)	20 mm (³ / ₄ in.) 301870	11 to 13.6 N•m (100 to 120 in.-lb) for the first four runs; 11 N•m (100 in.-lb) starting with the fifth run
	338903 (used with Type 21 rotor)	20 mm (³ / ₄ in.) 301870	11 N•m (100 in.-lb)
Hex driver (841884)	303624 303658	8 mm (⁵ / ₁₆ in.) 303379	hand tighten
Hex driver (841883)	303113, 346256, 305022, 330860, 338907, 303319, 302359, 326891, 302133, 326905, 338903, 337927	11 mm (⁷ / ₁₆ in.) 301870	hand tighten

* Unless otherwise indicated, caps are clear-anodized aluminum.

† Unless otherwise indicated, cap nuts are aluminum.

3. Slide the tube up around the stem PAST the O-ring or gasket as shown in Figure 3-4, slightly rotating the cap assembly. The tube wall should pass between the O-ring or gasket and the crown so that the top of the tube rests on the underside of the crown. Tighten the nut by hand just enough to hold the tube cap in place.
4. Position the capped tube in the appropriate-sized hole from the underside of the tube-cap vise (305075). The vise must be correctly mounted to the bench with the clamping positioned on the right (see Figure 3-5), or crimping of the crown may result. While holding the tube with one hand, tighten the vise around the crown by using the clamping knob. Make sure that the cap and the tube are level (horizontal).
5. Tighten the cap nut as described in Table 3-4.
6. Use a syringe to finish filling the tube through the filling hole in the stem.
 - Thinwall tubes must be as full as possible to prevent tube collapse.

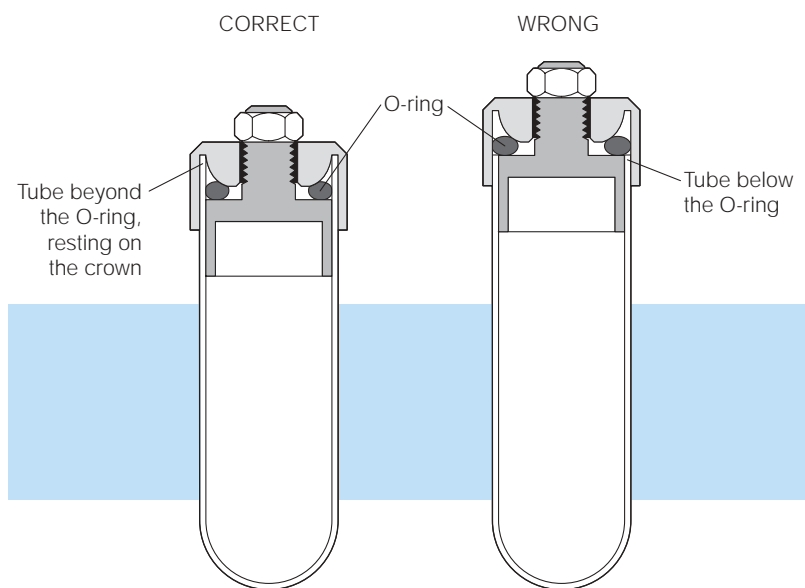

Figure 3-4. Tube Cap Installation. The tube must be pushed up past the O-ring so that the crown will clamp the tube and NOT the O-ring.

- Thickwall tubes may be filled to within 13 mm of the top, but may still collapse if not completely full.
- Stainless steel tubes may be filled to any level.

Tubes placed opposite each other in the rotor must be filled to the same level.

FILLING AND CAPPING BOTTLES

To prevent spillage and provide support, polycarbonate and polypropylene bottles used in fixed angle rotors must be capped when fill levels exceed the maximum level allowed for uncapped bottles. Bottles should be filled to maximum fill levels when spun at maximum rated speeds. Unless specified otherwise, the minimum recommended volume for bottles is half full; this will require reduced rotor speed for optimum labware performance. Refer to Table 3-5 and the applicable rotor manual for bottle fill levels and cap requirements.

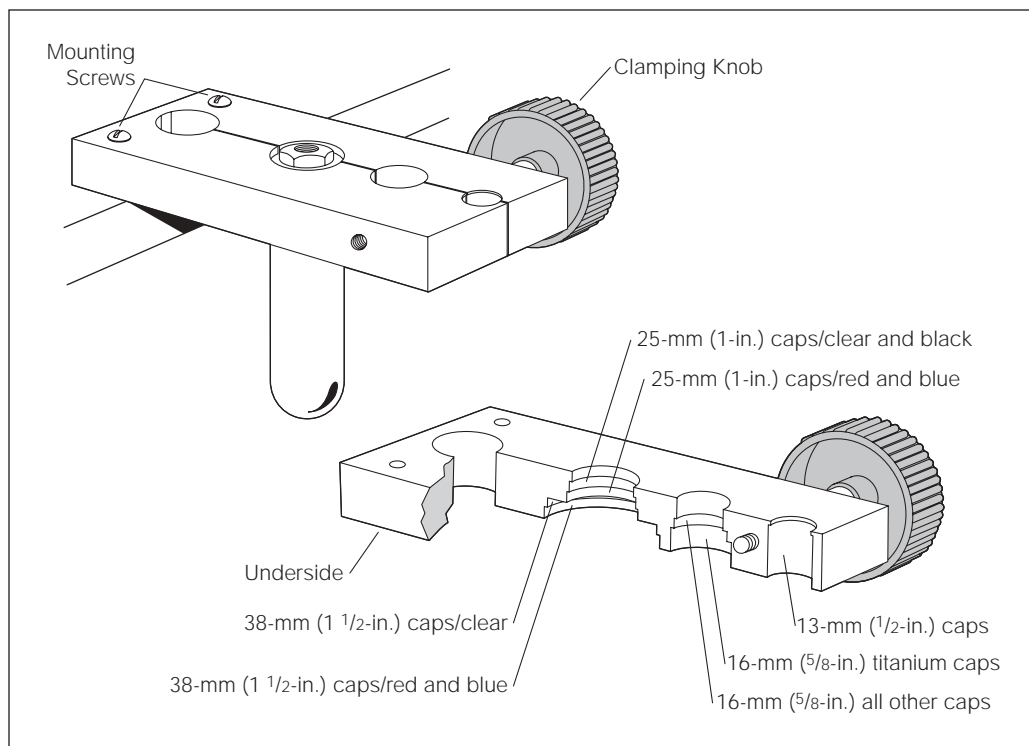
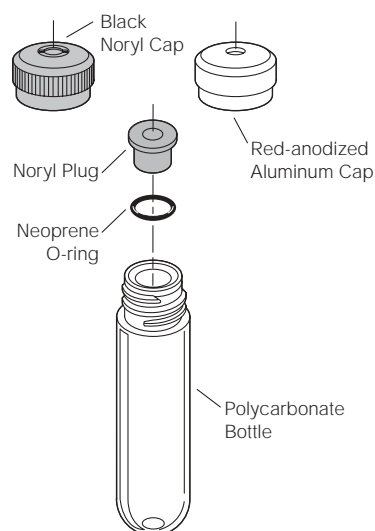

Figure 3-5. Tube Cap Vise. Screw the vise to a bench or table top for operation. The vise must be correctly mounted, with the clamping knob positioned on the right, or crimping of the crown may result.



Cap bottles with three-piece cap assemblies as follows:

1. Be sure the O-ring, plug, and bottle lip are dry and free of lubrication.
2. Place the O-ring on the underside of the plug.
3. Insert the plug into the neck of the bottle, ensuring that no fluid contacts the O-ring.
4. Tighten the cap by hand.

Table 3-5. Available Bottles, Assembly and Operation. Bottles are polycarbonate unless otherwise indicated.

Bottle		Required Cap Assembly		Bottle and Cap Assembly	Volume (mL)		Rotor	Maximum Speed (rpm) ^a	Required Adapter
Part Number	Dimensions (mm)	Material	Part Number		Max.	Min.			
355656	16 × 64	Noryl	355604	355615	8.5	8.5	Type 50	50 000	
355651	16 × 76	Noryl	355604	355603	10.4	5 ^a	Types 90 Ti, 80 Ti, 75 Ti, 70.1 Ti, 65	65 000	
							Type 50 Ti	50 000	
							Type 40	40 000	
^b	11 × 79	polypropylene	^b	355672	10	10	Type 28	20 000	342327/ 870329
355654	25 × 89	aluminum	355619	355618	26.3	16 ^a	Types 70 Ti, 60 Ti	60 000	
							Type 55.2 Ti	55 000	
							Type 50.2 Ti	50 000	
		Noryl	355617	355616	26.3	16	Type 30	30 000	
355670	29 × 102	polypropylene	355601	357001	50	40	Type 28	20 000 ^c	
							Type 16	14 000	356977
^b	29 × 102	polypropylene	355601	357000 ^d	50	40	Type 28	20 000 ^c	
							Type 16	14 000	356977
^b	29 × 102	—	—	357003 ^d	50	40	Type 16	14 000	356977
							Type 28	20 000	
355655	38 × 102	aluminum	355623	355622	70	35 ^a	Type 45 Ti	45 000	
		Noryl	355621	355620	70	35	Type 35	35 000	
							Type 21	21 000	
^b	52 × 134	—	—	355674	150	150	Type 16	5 000	339362
355627	60 × 120	Delrin (w/Noryl plug)	362247	334025	250	250	Type 19	19 000	
358275	64 × 124	Noryl	358977	356013	250	190	Type 16	16 000	
^b	32 × 124	—	—	355666	250	190	Type 16	14 000	334915
358326 ^d	64 × 124	Noryl	358977	356011 ^e	250	190	Type 16	16 000	

^a Several rotors must be centrifuged at reduced speeds when bottles are filled below maximum fill volume: Types 90 Ti, 80 Ti, 75 Ti, 70.1 Ti, and 65 at 60 000 rpm; Types 70 Ti, 60 Ti, 55.2 Ti, and 50.2 Ti at 50 000 rpm; Type 45 Ti at 35 000 rpm.

^b Available only as bottle and cap assembly.

^c Above 20 000 rpm, insert assembly (355601) must be used.

^d Polyallomer

^e Polypropylene

SAMPLE RECOVERY



CAUTION

If disassembly reveals evidence of leakage, you should assume that some fluid escaped the container or rotor. Apply appropriate decontamination procedures to the centrifuge, rotor, and accessories.

Sample recovery depends on the type of labware used, the component(s) isolated, and the analysis desired. The Beckman Coulter Universal Fraction Recovery System (343890) can be useful when recovering sample from tubes (see publication L5-TB-081).

CAPPED TUBES

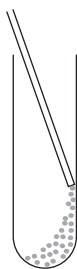

The usual methods of recovering supernatants or pellets include decanting or withdrawing the gradient and scraping pellets from the tube bottom.

- Remove tube caps carefully to avoid sample mixing.
- If tubes will be reused, scrape pellets out with a plastic or wooden tool; scratches on tube interiors caused by abrasive or sharply pointed tools can result in tube failure during subsequent runs.

OptiSeal TUBES

Centrifugation exerts high forces on plastic labware. The effect of these forces on OptiSeal labware is compression of the tube, characterized by tube deformation that, even if slight, causes a decrease in internal volume. OptiSeal labware is designed to contain the resulting slight pressure increase during separation, as well as during normal post-separation handling. However, a small volume ($\approx 50 \mu\text{L}$) of fluid may occasionally “ooze” from around the plug onto the tube stem area as a plug is removed. Therefore, we recommend using a tissue to contain escaped fluid when extracting plug assemblies from tubes.

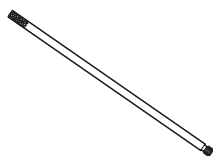

Spacer Removal Tool

1. After centrifugation, use the spacer removal tool (338765) or a hemostat to carefully remove the spacers, taking care not to scratch the rotor cavities. (A tube will sometimes come out of the rotor cavity along with the spacer. Separate the tube from the spacer with a twisting motion.)

NOTE

SW 32 Ti and SW 28 rotors only—Use the spacer removal tool (338765) to remove the spacer and tube together from the rotor bucket. Place the tubes in the rack. Grasp the tube and use the spacer removal tool in a lifting and twisting motion to remove the spacer.

NOTE

Centrifugation causes a slight vacuum to build up in the tube cavity, occasionally resulting in a suction effect when removing the tubes from the rotor. This effect is especially pronounced in a rotor that has been centrifuged at a low temperature. A brief delay (approximately 5 minutes) after the rotor comes to rest before removing the tubes will make tube removal easier. If you experience difficulties in removing the tubes from the rotor, use a gentle twisting or rocking motion, and remove the tube slowly to avoid sample mixing.

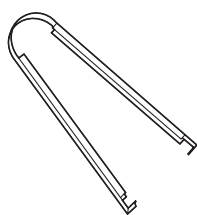

Extraction Tool
(361668)

2. Remove the tube with the extraction tool (361668), grasping the base of the stem only—do NOT try to remove the tubes by pulling on the plugs. Some tube deformation occurs during centrifugation, which causes a slight internal pressure to develop inside the tube.
3. Place the tubes back into the tube rack. Openings in the rack allow the tubes to be pierced either from the bottom or sides, permitting fractions to be easily collected regardless of the type of separation.

NOTE

If you plan to collect particles from the tube side or bottom, first create an air passage by removing the tube plug (see instructions below) or inserting a hollow hypodermic needle in the top of the tube.

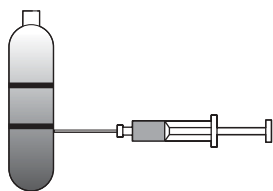

4. Use one of the following methods to retrieve the sample:

- Puncture the side of the tube just below the sample band with a needle and syringe and draw the sample off. Take care when piercing the tube to avoid pushing the needle out the opposite side.

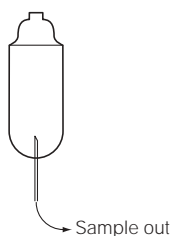

- Puncture the bottom of the tube and collect the drops.

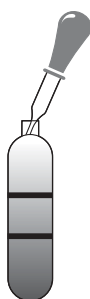

- Aspirate the sample from the tube top by removing the tube plug (see instructions below), then aspirating the sample with a Pasteur pipette or needle and syringe.

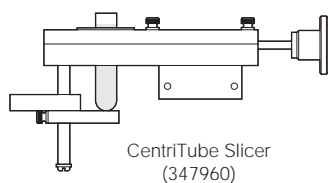

- Slice the tube, using the Beckman CentriTube Slicer (303811). Refer to publication L-TB-010 for instructions for using the CentriTube Slicer. Use CentriTube Slicer (347960) and CentriTube Slicer Adapter (354526) for 13-mm tubes. (Tubes are pressurized after centrifugation, so pierce the tube top with a needle to relieve pressure before slicing.)

Removing Plugs from Tubes

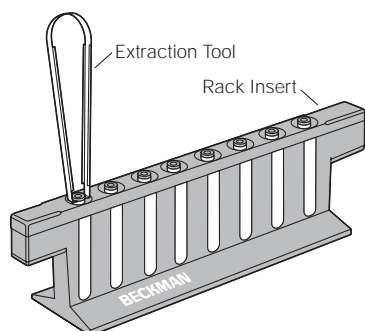

1. Place the tube rack insert over the tubes in the rack.
2. Press down on the rack insert on each side of the tube being unplugged to hold the tube in place during plug removal.

NOTE

Do not hold onto or squeeze the tubes. Tube contents will splash out when the plug is removed if pressure is applied to the tube.

3. While pressing down on the rack insert, use the extraction tool to firmly grasp the plug.
4. Use a slight twisting motion to slowly release any residual internal pressure when pulling the plug assembly from the tube.
5. Repeat for each tube.

QUICK-SEAL TUBES

There are several methods of recovering fractions from Quick-Seal tubes. One of the following procedures may be used.

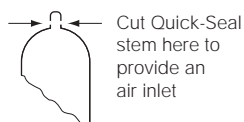

NOTE

If you plan to collect particles from the tube side or bottom, first create an air passage by snipping the stem or inserting a hollow hypodermic needle in the top of the tube.

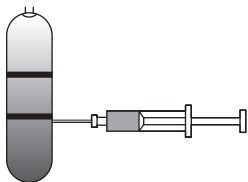

- Puncture the side of the tube just below the band with a needle and syringe and draw the sample off. Take care when piercing the tube to avoid pushing the needle out the opposite side.

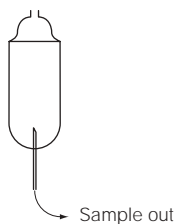

- Puncture the bottom of the tube and collect the drops.

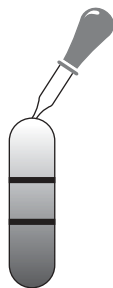

- Aspirate the sample from the tube top by snipping off the tube stem, then aspirating the sample with a Pasteur pipette or needle and syringe.

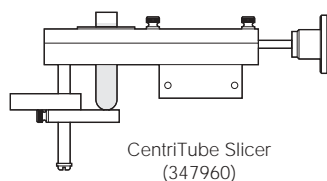

- Slice the tube, using the Beckman CentriTube Slicer (347960). Refer to publication L-TB-010 for instructions for using the CentriTube Slicer.

For additional information on fraction recovery systems available from Beckman Coulter, refer to the latest edition of *Ultracentrifuge Rotors, Tubes & Accessories* (publication BR-8101).

MAKING ULTRA-CLEAR TUBES WETTABLE

The following method of making Ultra-Clear tubes wettable has proven successful for some users:

1. Polyvinyl alcohol (2 g) was dissolved in distilled water (50 mL) by stirring and heating to gentle reflux.
2. Isopropanol (50 mL) was slowly added to the hot solution and stirring and heating continued until a clear solution was obtained.
3. The solution was then allowed to cool to room temperature.

4. Ultra-Clear tubes were filled with the coating solution, then aspirated out with a water pump after 15 minutes, leaving a thin film on the tube walls. A small amount of solution that collected in the tube bottoms after standing was removed with a pipette.
5. The tubes were left open to dry at room temperature overnight, then filled with distilled water. After standing overnight at room temperature, the distilled water was poured out.
6. Finally, the tubes were briefly flushed with water, tapped to remove excess liquid, and left to dry.



Using Fixed Angle Rotors

This section contains instructions for using fixed angle rotors in preparative ultracentrifuges. In addition to these instructions, observe procedures and precautions provided in the applicable rotor and ultracentrifuge manuals.

Refer to Section 2 for labware selection information, and Section 3 for recommended filling and sealing or capping requirements and for sample recovery procedures. Refer to Section 7 for information on the care of rotors and accessories.

DESCRIPTION

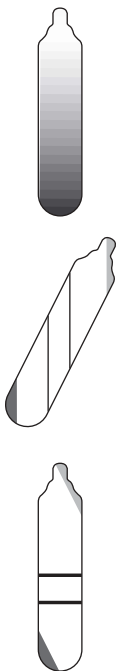

Fixed angle rotors (see Figure 4-1) are general-purpose rotors that are especially useful for pelleting and isopycnic separations. Refer to Table 4-1 for general rotor specifications.

Tubes in fixed angle rotors are held at an angle (usually 20 to 35 degrees) to the axis of rotation in numbered tube cavities. The tube angle shortens the particle pathlength compared to swinging bucket rotors, resulting in reduced run times.

Most fixed angle rotors have a lid secured by a handle. Most handles have holes so that a screwdriver or metal rod can be used to loosen the lid after centrifugation. The lids of some high-performance rotors have either two or four small holes to provide a temporary vent, which prevents rotor damage by allowing liquid to escape in the event of tube leakage.

O-rings, made of Buna N rubber, are located in the rotor lid. The O-rings help to maintain atmospheric pressure inside the rotor during centrifugation, if they are properly lubricated.

Some rotors have fluted bodies, designed to eliminate unnecessary weight and minimize stresses.

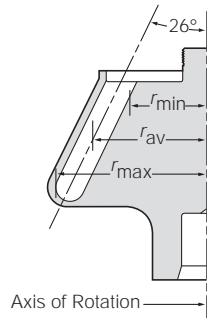

Type 100 Ti

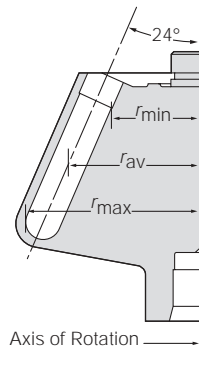

Type 70.1 Ti

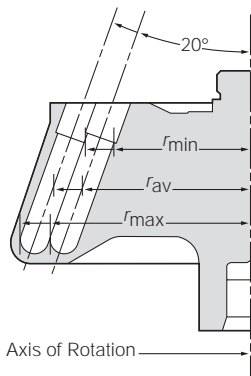

Type 50.4 Ti

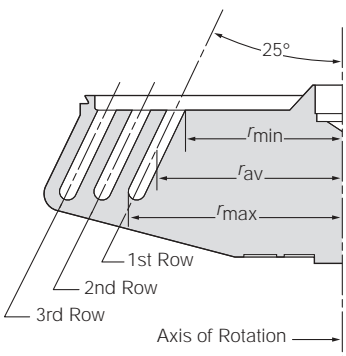

Type 25

Figure 4-1. Fixed Angle Rotors

Table 4-1. General Specifications for Beckman Coulter Preparative Fixed Angle Rotors.
Rotors in parentheses are no longer manufactured.

Rotor Type	Maximum Speed* (rpm)	Relative Centrifugal Field ($\times g$) at r_{\max}	Tube Angle (degrees)	Radial Distances (mm)			k Factor	Number of Tubes \times Tube Capacity (mL)
				r_{\max}	r_{av}	r_{\min}		
100 Ti	100 000	802 400	26	71.6	55.5	39.5	15	8 \times 6.8
90 Ti	90 000	694 000	25	76.5	55.4	34.2	25	8 \times 13.5
(80 Ti)	80 000	602 000	25.5	84.0	62.5	41.0	28	8 \times 13.5
(75 Ti)	75 000	502 000	25.5	79.7	58.3	36.9	35	8 \times 13.5
70.1 Ti	70 000	450 000	24	82.0	61.2	40.5	36	12 \times 13.5
70 Ti	70 000	504 000	23	91.9	65.7	39.5	44	8 \times 38.5
(65)	65 000	368 000	23.5	77.8	57.3	36.8	45	8 \times 13.5
(60 Ti)	60 000	362 000	23.5	89.9	63.4	36.9	63	8 \times 38.5
(55.2 Ti)	55 000	340 000	24	100.3	73.5	46.8	64	10 \times 38.5
50.4 Ti	50 000	312 000 [†]	20	111.5	96.2	80.8	33	44 \times 6.5
(50.3 Ti)	50 000	223 000	20	79.5	64.2	48.9	49	18 \times 6.5
50.2 Ti	50 000	302 000	24	107.9	81.2	54.4	69	12 \times 39
(50 Ti)	50 000	226 000	26	80.8	59.1	37.4	78	12 \times 13.5
(50)	50 000	196 000	20	70.1	53.6	37.0	65	10 \times 10
45 Ti	45 000	235 000	24	103.8	69.8	35.9	133	6 \times 94
(42.1)	42 000	195 000	30	98.6	68.8	39.1	133	8 \times 38.5
42.2 Ti	42 000	223 000	30	113.0	108.5	104.0	9	72 \times 230 μL
(40.3)	40 000	142 000	20	79.5	64.2	48.9	77	18 \times 6.5
(40)	40 000	145 000	26	80.8	59.1	37.4	122	12 \times 13.5
(35)	35 000	143 000	25	104.0	69.5	35.0	225	6 \times 94
(30)	30 000	106 000	26	104.8	77.0	49.1	213	12 \times 38.5
(28)	28 000	94 800	34	108.0	70.0	32.0	393	8 \times 50
25	25 000	92 500 [‡]	25	132.1	122.8	113.4	62	100 \times 1
(21)	21 000	60 000	18	121.5	90.9	60.3	402	10 \times 94
19	19 000	53 900	25	133.4	83.9	34.4	951	6 \times 250
(16)	16 000	39 300	25	137.0	86.0	35.0	1350	6 \times 250

* Maximum speeds are based on a solution density of 1.2 g/mL in all fixed angle rotors except for the Type 60 Ti, Type 42.1, and the Type 35, which are rated for a density of 1.5 g/mL.

[†] Maximum RCF measured at outer row.

[‡] Maximum RCF measured at the third row. Radial distances are those of the third row.

 **NOTE**

Although rotor components and accessories made by other manufacturers may fit in the Beckman Coulter rotor you are using, their safety in the rotor cannot be ascertained by Beckman Coulter. Use of other manufacturers' components or accessories in a Beckman Coulter rotor may void the rotor warranty, and should be prohibited by your laboratory safety officer. Only the components and accessories listed in the applicable rotor manual should be used.

TUBES AND BOTTLES

Fixed angle rotors can accommodate a variety of tube types, listed in the rotor manual. Refer to Section 3, for tube filling and sealing or capping requirements. Observe the maximum rotor speeds and fill volumes listed in the applicable rotor instruction manual.

Fill volumes, maximum rotor speeds, and capping requirements for ultracentrifuge bottles are listed in Section 3. Some rotors must be centrifuged at reduced speeds when bottles are run partially filled. Refer to the applicable rotor manual for specific minimum and maximum fill volumes and rotor speeds.

When running uncapped tubes, observe the maximum rotor speeds and fill volumes listed in Table 4-2.

ROTOR PREPARATION AND LOADING

For runs at other than room temperature, refrigerate or warm the rotor beforehand for fast equilibration.

Table 4-2. Maximum Run Speeds and Tube Volumes for Uncapped Tubes in Fixed Angle Rotors

Nominal Dimensions (mm)	Part Number		Maximum Volume (mL)	Maximum Capless Speed* (rpm)		Rotor Type†
	Polycarbonate	Polyallomer		Polycarbonate	Polyallomer	
7 × 20	343775	343621	230 µL	42 000	42 000	42.2 Ti
7 × 20	342303‡	—	230 µL	42 000	—	42.2 Ti
8 × 51	355657	—	1	45 000	—	50.4 Ti
				25 000	—	25
11 × 89	355632	355641	3.5	30 000	30 000	45 Ti, 35
13 × 64	355645	355644	4	50 000	30 000	50.4 Ti, 50.3 Ti, 40.3
16 × 64	355647	355646	6.5	50 000	50 000	50
			8	50 000	30 000	80 Ti, 75 Ti, 70.1 Ti, 50 Ti
				40 000	30 000	40
16 × 76	355630	355640	7.5	50 000	30 000	65, 50 Ti
			8	55 000	30 000	90 Ti
			16.5	45 000	20 000	70 Ti, 60 Ti, 55.2 Ti, 50.2 Ti
25 × 89	355631	355642	24	40 000	20 000	42.1
			18	30 000	20 000	30
25 × 102	335432	—	12	6 000	—	28
28 × 102	357006	357007	35	20 000	20 000	28
38 × 102	355628	355643	44	30 000	15 000	45 Ti, 35
			34	21 000	15 000	21

* Maximum speeds are those for capless tubes, tested at 25°C for 24 hours.

† Rotors are not listed for tubes used with adapters.

‡ Cellulose propionate

PRERUN SAFETY CHECKS



Read all safety information in the rotor manual before using the rotor.

1. Make sure that the rotor and lid are clean and show no signs of corrosion or cracking.
2. Make sure the rotor is equipped with the correct overspeed disk (refer to Section 1). If the disk is missing or damaged, replace it as described in Section 7.
3. Check the chemical compatibilities of all materials used. (Refer to Appendix A.)
4. Verify that tubes, bottles, and accessories being used are listed in the appropriate rotor manual.

ROTOR PREPARATION AND LOADING

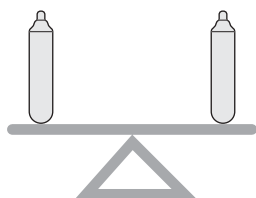

1. Be sure that metal threads in the rotor are clean and lightly but evenly lubricated with Spinkote™ lubricant (306812). Also ensure that O-rings are lightly but evenly coated with silicone vacuum grease (335148).
2. Dry the exterior of the tubes. (Moisture between the tube and the rotor cavity may lead to tube collapse and increase the force required to extract the tube.) Slide the filled and capped or sealed tubes into the tube cavities. Tubes must be arranged symmetrically in the rotor (see Figure 1-6). Opposing tubes must be filled to the same level with liquid of the same density. Refer to ROTOR BALANCE in Section 1.

NOTE

Place filled tubes in at least two opposing cavities. Make sure that cavities in use also have the proper spacers inserted before installing the rotor lid. *Do not put spacers in cavities that do not contain tubes.*

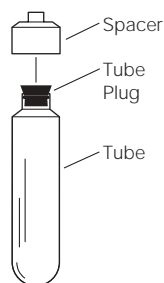

3. Use the required spacers and/or floating spacers, if necessary, to complete the loading operation.

- If *OptiSeal tubes* are being used, install a spacer over each plugged tube (refer to the applicable rotor manual). Leave cavities without tubes completely empty.

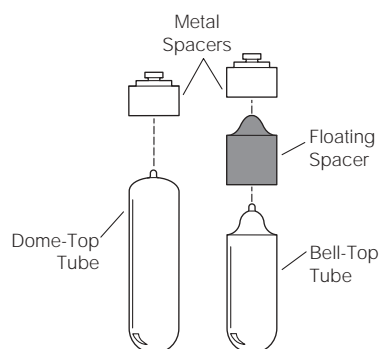

- If *Quick-Seal tubes* are being used, install spacers and/or floating spacers over sealed tubes (refer to the applicable rotor manual). The particular type of tube support for Quick-Seal tubes in fixed angle rotors depends on the length of the tube, but the top of the tube must be supported. Leave cavities without tubes completely empty.

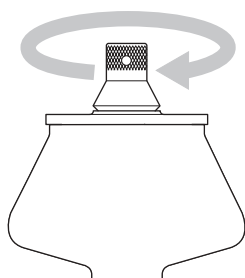

4. Place the lid on the rotor and tighten it, as firmly as possible, with the handle. Screw the handle down clockwise to fully compress the O-rings.



CAUTION

The lid should not touch the tube caps. If the lid touches the caps, the caps are not seated properly on the tubes. Remove the tubes from the rotor and recap them (refer to Section 3). Check the tube cavity for foreign matter.

OPERATION

For runs at other than room temperature, refrigerate or warm the rotor beforehand for fast equilibration.

INSTALLING THE ROTOR

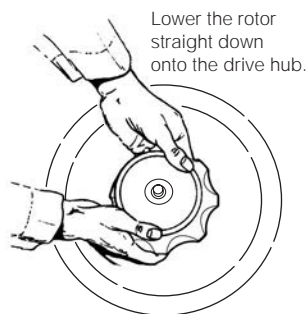

1. Carefully lower the rotor straight down onto the drive hub. If the rotor has drive pins, install it so that the pins are at a 90-degree angle to the pins in the drive hub. Careful installation will prevent disturbing the sample or tripping the imbalance detector.
2. Refer to the centrifuge instruction manual for detailed operating information.

REMOVAL AND SAMPLE RECOVERY



CAUTION

If disassembly reveals evidence of leakage, you should assume that some fluid escaped the rotor. Apply appropriate decontamination procedures to the centrifuge and accessories.

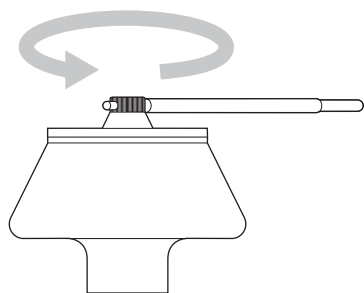

1. Remove the rotor from the centrifuge by lifting it straight up and off the drive hub.
2. Unscrew the handle counterclockwise and remove the lid. Some rotor handles have holes so that a screwdriver or metal rod can be used to loosen the lid.
3. Remove spacers and/or floating spacers with a removal tool (338765) or hemostat.
4. Remove tubes or bottles from the rotor using one of the following procedures. Refer to Figure 4-2 for removal tools.



NOTE

When removing a tube cap, do not remove the cap nut, or the stem may drop into the tube contents and disturb the separation. Instead, loosen the nut just enough to remove the cap assembly as a unit.

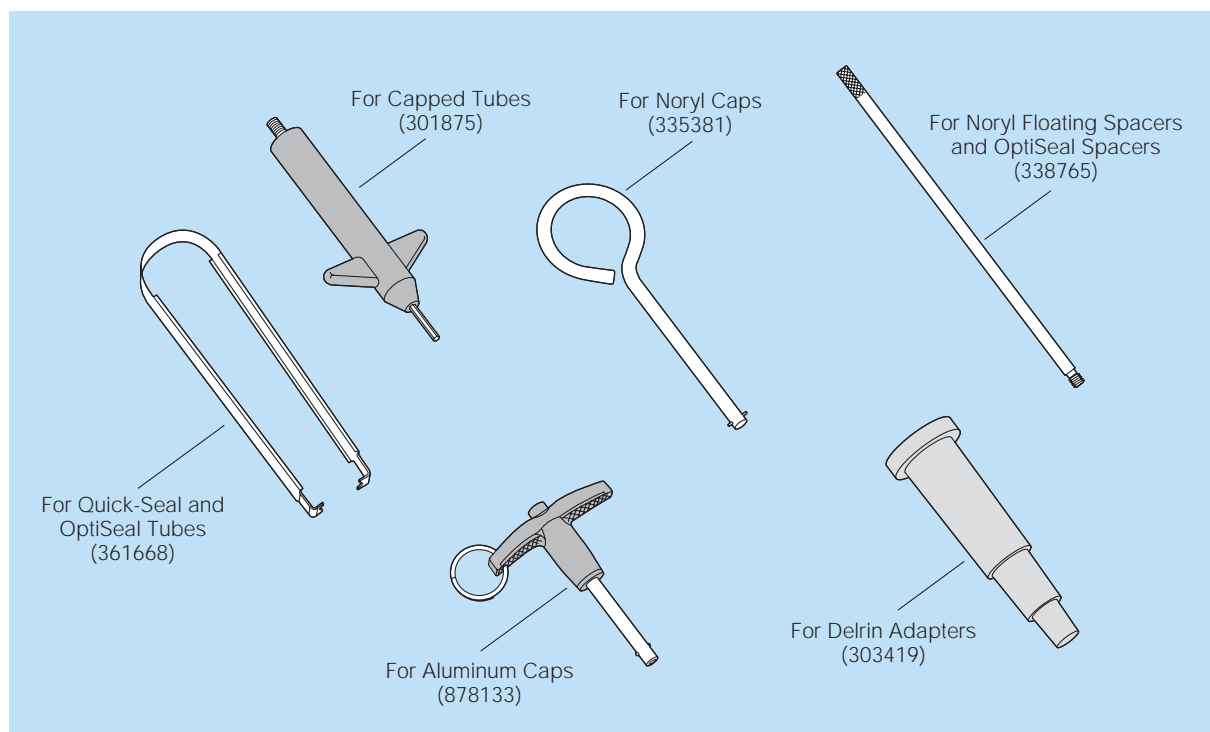
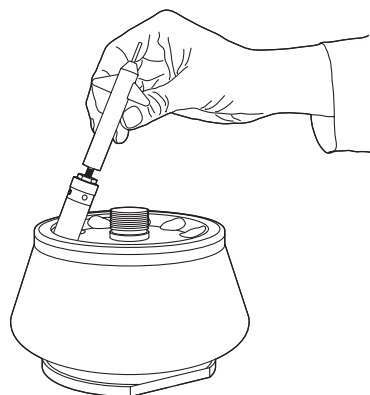

Figure 4-2. Removal Tools Used in Fixed Angle Rotors



- Extract *capped tubes* using the appropriate removal tool. Insert the threaded end of the tool into the cap and screw at least one turn. If necessary, turn the tube slightly to break any vacuum seal created between the tube and the cavity, and pull the tube out. Use the hex-key end of the removal tool to remove the cap setscrew, but try not to squeeze the tube. With the setscrew removed, supernatant liquid can be withdrawn from the tube, or the tube bottom can be punctured for fraction collection.
 - Extract *capless tubes* using forceps or a hemostat, and *OptiSeal* or *Quick-Seal tubes* with the removal tool (361668).
 - To remove *polycarbonate bottles* with black Noryl caps, insert the crossbar end of the removal tool (335381) into the cap slot and turn until the crossbar is past the slot. Pull the bottle out.
 - For bottles with red aluminum caps, depress the button of the removal tool (878133) and insert the end of the tool into the cap hole. Release the button and pull the bottle out.
5. Remove adapters using the appropriate removal tool.
 6. Refer to Section 3, for sample recovery methods.



Using Swinging Bucket Rotors

This section contains instructions for using swinging bucket rotors in preparative ultracentrifuges. In addition to these instructions, observe procedures and precautions provided in the applicable rotor and ultracentrifuge manuals.

Refer to Section 2 for labware selection information, and Section 3 for recommended filling and sealing or capping requirements and for sample recovery procedures. Refer to Section 7 for information on the care of rotors and accessories.

DESCRIPTION

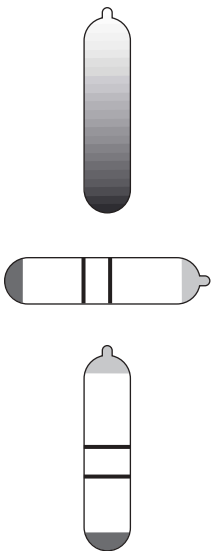

Swinging bucket rotors (see Figure 5-1) are most frequently used for density gradient separations, either isopycnic or rate zonal. Refer to Table 5-1 for general rotor specifications.

Tubes in swinging bucket rotors are held in the rotor buckets. Buckets are attached to the rotor body by hinge pins or a crossbar. The buckets swing out to a horizontal position as the rotor accelerates, then seat against the rotor body for support. Bucket and rotor body positions are numbered for operator convenience.

Each bucket is sealed by an O-ring or gasket between the bucket and the bucket cap. Caps are either a small, flat cap, tightened with a screwdriver, or a cap that is integral with the hanger mechanism, screwed into the bucket by hand.

Some swinging bucket rotors have a hollow handle on top, designed for use with a temperature-sensing thermistor and a rotor stabilizer,¹ features of the early model ultracentrifuges (Models L and L2).

¹ Operators using Model L2 ultracentrifuges should refer to individual rotor manuals for the stabilizer level to be used for Beckman Coulter's newer rotors.

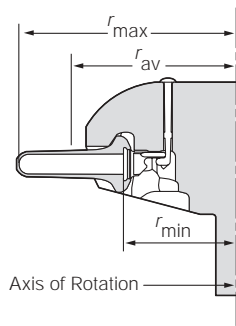

SW 60 Ti

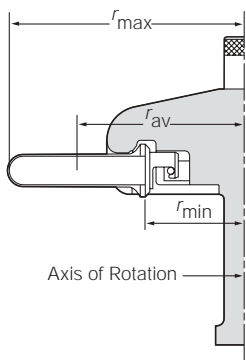

SW 40 Ti

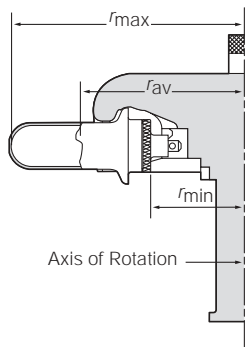

SW 28

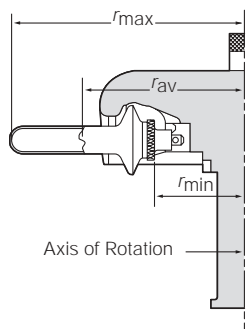

SW 28.1

Figure 5-1. Swinging Bucket Rotors

Table 5-1. General Specifications for Beckman Coulter Preparative Swinging Bucket Rotors.
Rotors listed in parentheses are no longer manufactured.

Rotor	Maximum Speed* (rpm)	Relative Centrifugal Field ($\times g$) at r_{\max}	Radial Distances (mm)			k Factor	k' Factors [†]			Number of Tubes \times Tube Capacity (mL)
			r_{\max}	r_{av}	r_{\min}		(g/mL) $\rho = 1.3$	(g/mL) $(\rho = 1.5)$	(g/mL) $\rho = 1.7$	
(SW 65 Ti)	65 000	421 000	89.0	65.1	41.2	46	126	116	112	3 \times 5
SW 60 Ti	60 000	485 000	120.3	91.7	63.1	45	126	115	111	6 \times 4
SW 55 Ti	55 000	368 000	108.5	84.6	60.8	48	135	123	118	6 \times 5
(SW 50.1)	50 000	300 000	107.3	83.5	59.7	59	165	151	145	6 \times 5
SW 41 Ti	41 000	288 000	153.1	110.2	67.4	124	335	307	295	6 \times 13.2
SW 40 Ti	40 000	285 000	158.8	112.7	66.7	137	368	338	325	6 \times 14
SW 32 Ti	32 000	175 000	152.5	109.7	66.8	204	468	428	412	6 \times 38.5
SW 32.1 Ti	32 000	187 000	162.8	113.6	64.4	228	613	560	536	6 \times 17
(SW 30.1)	30 000	124 000	123.0	99.2	75.3	138	393	360	346	6 \times 8
(SW 30)	30 000	124 000	123.0	99.2	75.3	138	393	360	346	6 \times 20
SW 28.1 [‡]	28 000	150 000	171.3	122.1	72.9	276	757	694	668	6 \times 17
SW 28 [‡]	28 000	141 000	161.0	118.2	75.3	246	680	622	600	6 \times 38.5
(SW 25.1)	25 000	90 400	129.2	92.7	56.2	337	917	840	809	3 \times 34

* Maximum speeds are based on a solution density of 1.2 g/mL in all swinging bucket rotors.

[†] Calculated for 5 to 20% (wt/wt) sucrose at 5°C, using the tables in Appendix I of *Techniques of Preparative, Zonal, and Continuous Flow Ultracentrifugation* (publication DS-468).

[‡] SW 28.1M and SW 28M rotors (no longer manufactured) were specially modified versions of the SW 28.1 and SW 28 rotors, and are equipped with a mechanical overspeed system. These rotors are otherwise identical to the SW 28.1 and SW 28 rotors.

NOTE

Although rotor components and accessories made by other manufacturers may fit in the Beckman Coulter rotor you are using, their safety in the rotor cannot be ascertained by Beckman Coulter. Use of other manufacturers' components or accessories in a Beckman Coulter rotor may void the rotor warranty, and should be prohibited by your laboratory safety officer. Only the components and accessories listed in the applicable rotor manual should be used.

TUBES AND BOTTLES

Swinging bucket rotors can accommodate a variety of tube types, listed in the applicable rotor manual. Refer to Section 3 for tube filling and sealing or capping requirements. Observe the maximum rotor speeds and fill volumes listed in the rotor instruction manual.

ROTOR PREPARATION AND LOADING

For runs at other than room temperature, refrigerate or warm the rotor beforehand for fast equilibration.

NOTE

All buckets, loaded or empty, must be positioned on the rotor body for every run.

PRERUN SAFETY CHECKS



Read all safety information in the rotor manual before using the rotor.

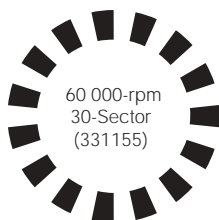

1. Make sure that the rotor body, buckets, and bucket caps are clean and show no signs of corrosion or cracking.
2. Make sure the rotor is equipped with the correct overspeed disk (refer to Section 1). If the disk is missing or damaged, replace it as described in Section 7.
3. Check the chemical compatibilities of all materials used. (Refer to Appendix A.)
4. Verify that tubes, bottles, and accessories being used are listed in the appropriate rotor manual.

ROTOR PREPARATION AND LOADING

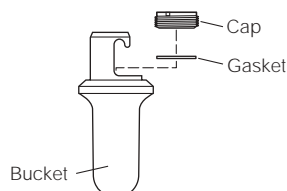

1. If the rotor has hinge pins, replace any pin that has stripped threads.
2. Be sure that bucket threads are clean and lightly but evenly lubricated with Spinkote™ lubricant (306812), as required.
3. Remove the bucket gaskets or O-rings and coat them lightly but evenly with silicone vacuum grease (335148). Install gaskets or O-rings in the buckets.



CAUTION

Never run a filled bucket without a gasket or O-ring, as the bucket contents may be lost, leading to rotor imbalance and possible failure.

4. Dry the exterior of the tubes. (Moisture between the tube and the bucket may lead to tube collapse and increase the force required to extract the tube.) Slide the filled and sealed tubes into the buckets. Loaded buckets can be supported in the bucket holder rack available for each rotor.
5. Use the required spacers and/or floating spacers, if necessary, to complete the loading operation.

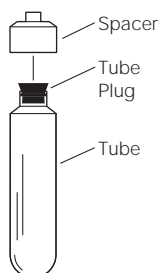

- If *OptiSeal tubes* are being used, install a spacer over each plugged tube (refer to the applicable rotor manual). Leave buckets without tubes completely empty.
- If *Quick-Seal tubes* are being used, install spacers and/or floating spacers over sealed tubes (refer to the applicable rotor manual). The particular type of tube support for Quick-Seal tubes in swinging bucket rotors depends on the length of the tube, but the top of the tube must be supported. Leave buckets without tubes completely empty.

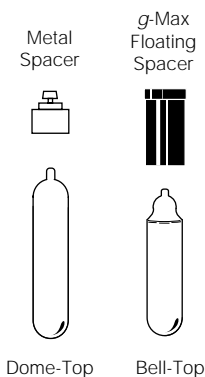

6. Match numbered caps with numbered buckets. Screw the caps into the bucket until there is metal-to-metal contact. Tighten flat caps with a screwdriver.

NOTE

For SW 32 Ti and SW 32.1 Ti rotors—use a lint-free cotton swab to apply Spinkote™ lubricant (396812) to cap grooves in the bucket tops. Match bucket caps with numbered buckets. Align the pins on each side of the cap with the guide slots in the bucket. Twist the cap clockwise until it stops (one-quarter turn).

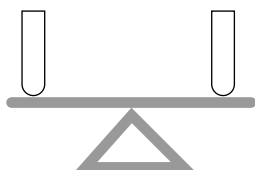

7. Attach all buckets, loaded or empty, to the rotor. Loaded buckets must be arranged symmetrically on the rotor (see Figure 1-6). *Opposing tubes must be filled to the same level with liquid of the same density.* Refer to ROTOR BALANCE in Section 1.

NOTE

Place filled tubes in at least two opposing buckets. *Do not put spacers in buckets that do not contain tubes.*

- *If the rotor has hook-on buckets*, make certain that both hooks are on the crossbar and that buckets are placed in their proper labeled positions.
- *If the rotor has hinge pins*, lightly lubricate the pin threads with Spinkote. Attach each bucket using the hinge pin tool (330069 and 330070).

OPERATION

For runs at other than room temperature, refrigerate or warm the rotor beforehand for fast equilibration.

INSTALLING THE ROTOR

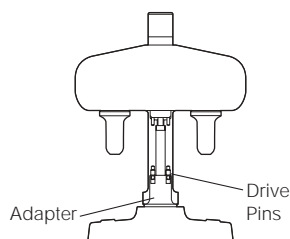

1. Note the location of the two small indentations on the rotor adapter (or the mechanical overspeed devices on older rotors). Their position indicates the location of the drive pins.

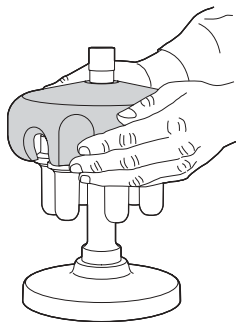

- Carefully lift the rotor with both hands (*do not carry a rotor with hook-on buckets by the rotor adapter; the buckets may be dislocated, resulting in an unbalanced rotor, spilled sample, and failed or collapsed tubes*) and lower it straight down onto the drive hub. Make sure that the rotor pins are at a 90-degree angle to the drive hub pins. Careful installation will prevent disturbing the sample or tripping the imbalance detector.

**CAUTION**

If hook-on buckets have been jarred during installation, check them with a mirror for proper vertical positioning (see Figure 5-2). Remove the rotor to correct any unhooked buckets.

- Refer to the centrifuge instruction manual for detailed operating information.



Figure 5-2. Checking Hook-on Bucket Positions After the Rotor is Installed. Note the partially unhooked bucket on the right.

REMOVAL AND SAMPLE RECOVERY



CAUTION

If disassembly reveals evidence of leakage, you should assume that some fluid escaped the rotor. Apply appropriate decontamination procedures to the centrifuge and accessories.

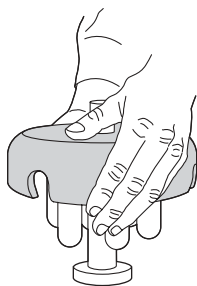

1. Remove the rotor from the centrifuge by lifting it straight up and off the drive hub.
2. Set the rotor on the rotor stand and carefully remove the buckets—lift buckets off crossbars or unscrew the hinge pins.
3. Remove the bucket caps and use the appropriate removal tool to remove the spacers and tubes.
4. Remove adapters using the appropriate removal tool.

While pressing the rubber tip against the adapter wall, pull the tool and adapter up and out of the cavity.

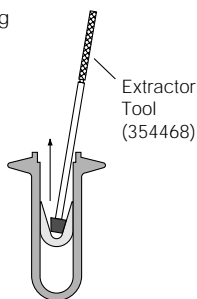

NOTE

If conical-shaped adapters that support konical tubes are difficult to remove after centrifugation, an extractor tool (354468) is available to facilitate removal.

5. Refer to Section 3 for sample recovery methods.



Using Vertical Tube and Near Vertical Tube Rotors

This section contains instructions for using vertical tube and near vertical tube rotors in preparative ultracentrifuges. In addition to these instructions, observe procedures and precautions provided in the applicable rotor and ultracentrifuge manuals.

Refer to Section 2 for labware selection information, and Section 3 for recommended filling and sealing or capping requirements and for sample recovery procedures. Refer to Section 7 for information on the care of rotors and accessories.

DESCRIPTION

Vertical tube and near vertical tube rotors are especially useful for isopycnic banding and rate zonal experiments. Some rotors have fluted bodies, designed to eliminate unnecessary weight and minimize stresses. Refer to Table 6-1 for general rotor specifications.

VERTICAL TUBE ROTORS

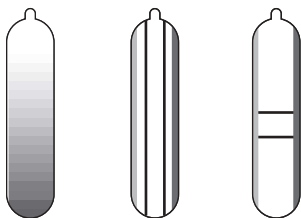

Tubes in vertical tube rotors (see Figure 6-1) are held parallel to the axis of rotation in numbered tube cavities. These rotors have plugs that are screwed into the rotor cavities over sealed OptiSeal or Quick-Seal tubes. The plugs (with spacers, when required) restrain the tubes in the cavities and provide support against the hydrostatic force generated by centrifugation.

Table 6-1. General Specifications for Beckman Coulter Preparative Vertical Tube and Near Vertical Tube Rotors. Rotors listed in parentheses are no longer manufactured.

Rotor Type	Maximum Speed* (rpm)	Relative Centrifugal Field ($\times g$) at r_{\max}	Tube Angle (degrees)	Radial Distances (mm)			k Factor	Number of Tubes \times Tube Capacity (mL)
				r_{\max}	r_{av}	r_{\min}		
Vertical Tube								
VTi 90	90 000	645 000	0	71.1	64.5	57.9	6	8 \times 5.1
(VTi 80)	80 000	510 000	0	71.1	64.5	57.9	8	8 \times 5.1
VTi 65.2	65 000	416 000	0	87.9	81.3	74.7	10	16 \times 5.1
VTi 65.1	65 000	401 700	0	84.9	76.7	68.5	13	8 \times 13.5
(VTi 65)	65 000	404 000	0	85.4	78.7	72.1	10	8 \times 5.1
(VC 53)	53 000	249 000	0	79.0	66.0	53.1	36	8 \times 39
VTi 50	50 000	242 000	0	86.6	73.7	60.8	36	8 \times 39
(VAC 50)	50 000	242 000	0	86.6	73.7	60.8	36	8 \times 39
Near Vertical Tube								
NVT 100	100 000	750 000	8	67.0	57.6	48.3	8	8 \times 5.1
NVT 90	90 000	645 000	8	71.1	61.8	52.4	10	8 \times 5.1
NVT 65.2	65 000	416 000	8.5	87.9	78.4	68.8	15	16 \times 5.1
NVT 65	65 000	402 000	7.5	84.9	72.2	59.5	21	8 \times 13.5

*Maximum speeds are based on a solution density of 1.7 g/mL in all vertical tube and near vertical tube rotors.

NEAR VERTICAL TUBE ROTORS

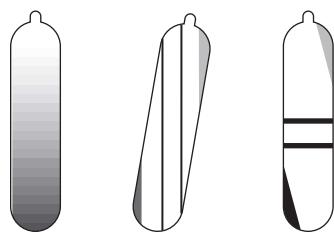

Tubes in near vertical tube rotors (see Figure 6-2) are held in numbered tube cavities at an angle to the axis of rotation (typically 7 to 10 degrees). The slight angle of the rotor significantly reduces run times from fixed angle rotors (with tube angles of 20 to 35 degrees) while allowing components that do not band under separation conditions to either pellet to the bottom or float to the top of the tube. Like the vertical tube rotors, these rotors have plugs to restrain and support sealed OptiSeal or Quick-Seal tubes.

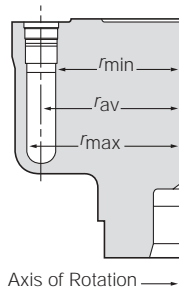
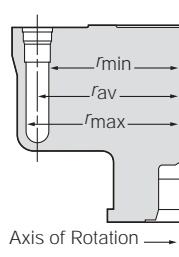

Figure 6-1. Vertical Tube Rotors

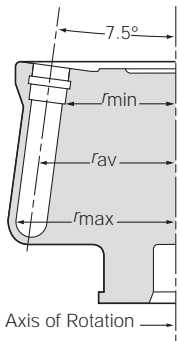
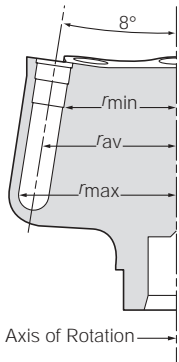

Figure 6-2. Near Vertical Tube Rotors

NOTE

Although rotor components and accessories made by other manufacturers may fit in the Beckman Coulter rotor you are using, their safety in the rotor cannot be ascertained by Beckman Coulter. Use of other manufacturers' components or accessories in a Beckman Coulter rotor may void the rotor warranty, and should be prohibited by your laboratory safety officer. Only the components and accessories listed in the applicable rotor manual should be used.

TUBES AND BOTTLES

Only OptiSeal or Quick-Seal tubes are used in these rotors. Refer to Section 3 for tube filling and sealing or plugging requirements. Observe the maximum rotor speeds and fill volumes listed in the applicable rotor instruction manual.

ROTOR PREPARATION AND LOADING

For runs at other than room temperature, refrigerate or warm the rotor beforehand for fast equilibration.

PRERUN SAFETY CHECKS

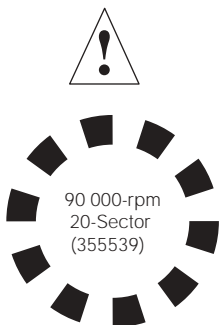

Read all safety information in the rotor manual before using the rotor.

1. Make sure that the rotor, plugs, gaskets, and spacers are clean and show no signs of corrosion or cracking. The high forces generated in these rotors can cause damaged components to fail.
2. Make sure the rotor is equipped with the correct overspeed disk (refer to Section 1). If the disk is missing or damaged, replace it as described in Section 7.

3. Check the chemical compatibilities of all materials used. (Refer to Appendix A.)
4. Verify that tubes and accessories being used are listed in the applicable rotor manual.

ROTOR PREPARATION AND LOADING

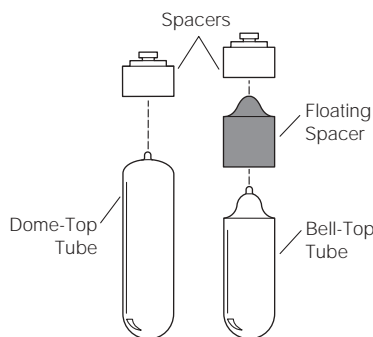
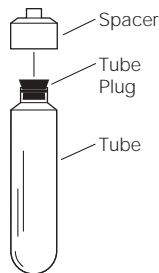
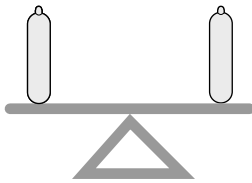
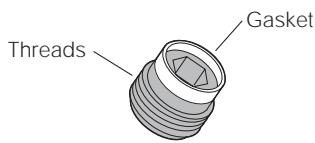

1. Be sure that plug threads are clean and lightly but evenly lubricated with Spinkote™ lubricant (306812).
2. If using a rotor vise, set the rotor into the vise, which should be bolted or clamped to a rigid surface.
3. Dry the exterior of the plugged (OptiSeal) or sealed (Quick-Seal) tubes. (Moisture between the tube and the rotor cavity may lead to tube collapse and increase the force required to extract the tube.) Slide the tubes into the tube cavities. Tubes must be arranged symmetrically in the rotor (see Figure 1-6). *Opposing tubes must be filled to the same level with liquid of the same density.* Refer to ROTOR BALANCE in Section 1. Place filled tubes in at least two opposing cavities.
4. It is important that each cavity being used is completely filled. Use the required spacers and/or floating spacers, if necessary, to complete the loading operation.
 - If *OptiSeal tubes* are being used, install a spacer over each plugged tube (refer to the applicable rotor manual). Leave cavities without tubes completely empty.
 - If *Quick-Seal tubes* are being used, install spacers and/or floating spacers over sealed tubes (refer to the applicable rotor manual). The particular type of tube support for Quick-Seal tubes depends on the length of the tube, but the top of the tube must be supported. Leave cavities without tubes completely empty.



CAUTION

To prevent plug damage, do not put spacers or plugs in cavities that do not contain tubes. Leave unused tube cavities completely empty.

5. Insert a rotor plug, with the white gasket-end down, over each spacer; screw in the plug.
6. Tighten each rotor plug as shown in Figure 6-3. Refer to Table 6-2 for the correct tightening tools and torque values. *To avoid stripping the plugs, apply downward pressure to the plug adapter while tightening the plugs.* The top surface of each rotor plug should be flush with the top surface of the rotor. (Plugs are not flush on the NVT 65.2 rotor; when properly torqued the plugs should protrude not more than 1 mm above the rotor top surface. Make sure that all plugs are level with each other.)

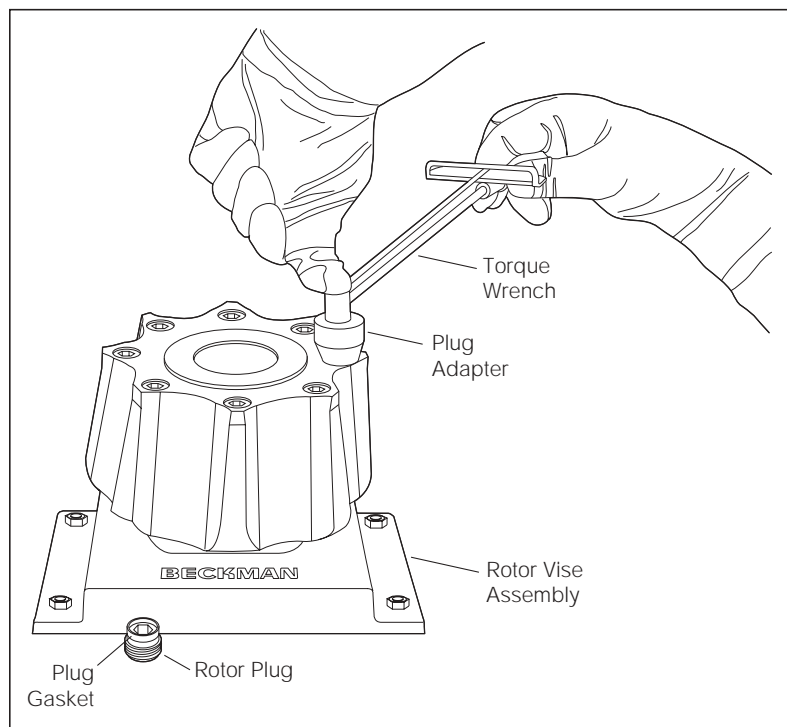

Figure 6-3. Preparing a Vertical Tube or Near Vertical Tube Rotor. See Table 6-2 for the correct tightening tools and torque values.

Table 6-2. Rotor Plugs and Tools Used for Vertical Tube and Near Vertical Tube Rotors

Rotor	Rotor Plug Part No.	Torque Wrench* Part No.	Plug Adapter Part No.	Torque Value
NVT 100	365895	858121	365891	11 N•m (100 in.-lb)
NVT 90	342881	858121	365891	13.6 N•m (120 in.-lb)
VTi 90	342881	858121	365891	13.6 N•m (120 in.-lb)
VTi 80	342881	858121	976959	13.6 N•m (120 in.-lb)
NVT 65.2	342881	858121	365891	13.6 N•m (120 in.-lb)
NVT 65	355875	858121	365891	13.6 N•m (120 in.-lb)
VTi 65.2	342881	858121	365891	13.6 N•m (120 in.-lb)
VTi 65.1	355875	858121	365891	13.6 N•m (120 in.-lb)
VTi 65	355874	858121	976959	10 to 11 N•m (90 to 100 in.-lb)
VC 53	355587	889096	355588	17.5 N•m (150 in.-lb)†
VTi 50	355587	889096	355588	17.5 N•m (150 in.-lb)†
VAC 50	355587	889096	355588	17.5 N•m (150 in.-lb)†

*Part number 858121 is a 1/4-in. drive torque wrench; part number 889096 is a 3/8-in. drive torque wrench.

† The VTi 50 and VC 53 rotors and rotor plugs must be cooled or warmed to operating temperature before torquing or leakage may result.



CAUTION

The VC 53 and VTi 50 rotors and rotor plugs must be cooled or warmed to the operating temperature prior to torquing, or leakage may occur.

- Remove the rotor from the vise.

OPERATION

For runs at other than room temperature, refrigerate or warm the rotor beforehand for fast equilibration.

INSTALLING THE ROTOR

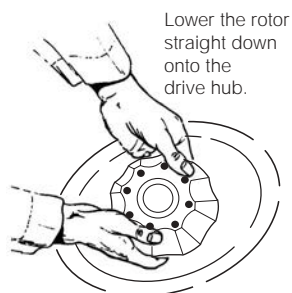

1. Carefully lower the rotor straight down onto the drive hub. Careful installation will prevent disturbing the sample or tripping the imbalance detector.
2. Refer to the centrifuge instruction manual for detailed operating information.

REMOVAL AND SAMPLE RECOVERY



CAUTION

If disassembly reveals evidence of leakage, you should assume that some fluid escaped the rotor. Apply appropriate decontamination procedures to the centrifuge and accessories.

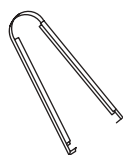
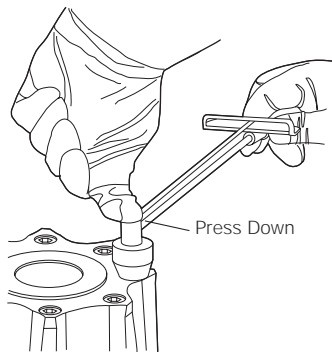

Tube
Removal Tool
(361668)

1. Remove the rotor from the centrifuge by lifting it straight up and off the drive hub.
2. If a rotor vise is required, set the rotor in the rotor vise.
3. Remove the rotor plugs, taking care to apply downward pressure on the plug adapter to avoid stripping the plugs.
4. Remove spacers with the appropriate removal tool or a hemostat. Use removal tool (338765) to remove floating spacers.
5. Remove tubes with the extraction tool (361668).
6. Refer to Section 3 for sample recovery methods.



Care and Maintenance

This section provides information on the care of rotors and accessories. Included is a list of some common operating problems with suggestions for their solutions. Rotors and accessories should be kept in optimal condition to minimize the chance of rotor or labware failure. In addition to these instructions, observe procedures and precautions provided in individual rotor manuals. Appendix A of this manual provides the chemical resistances of rotor and accessory materials to various acids, bases, salts, and solvents.

ROTOR CARE

Rotor care involves not only careful operating procedures but also careful attention to:

- Regular cleaning, decontamination, and/or sterilization as required,
- Frequent inspection,
- Corrosion prevention, and
- Regular and proper lubrication.

Do not use sharp tools on a rotor, as the surface can get scratched. Corrosion begins in scratches and may open fissures in the rotor with continued use. The corrosion process accelerates with speed-induced stresses. The potential for damage from corrosion is greatest in aluminum rotors and components.

CLEANING



Wash rotors and rotor components immediately if salts or other corrosive materials are used or if spillage has occurred. **DO NOT** allow corrosive materials to dry on the rotor.

NOTE

Do not wash rotor components or accessories in a dishwasher. Do not soak in detergent solution for long periods, such as overnight.

With normal usage, wash rotors frequently to prevent corrosion that can begin in scratches.



CAUTION

Do not immerse or spray a swinging bucket rotor body with water because liquid can become trapped in the hanger mechanism and lead to corrosion.

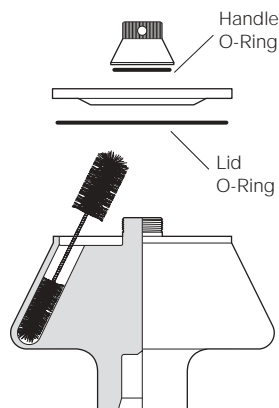

1. Use plastic or wooden tools to remove O-rings or gaskets for cleaning—*do not use metal tools* that could scratch anodized surfaces. Use a mild detergent such as Beckman Solution 555™ (339555), diluted 10 to 1 with water, and a soft brush to wash rotors and rotor components and accessories. (Most laboratory detergents are too harsh for aluminum rotors and components.) The Rotor Cleaning Kit (339558) contains two quarts of Solution 555 and brushes that will not scratch rotor surfaces.
2. Rinse thoroughly with water.
3. Air-dry the body or buckets upside down. *Do not use acetone to dry rotors.*

Wipe clean the O-rings or gaskets regularly (lubricate after cleaning). Replace them about twice a year or as required.

Frequently clean all surfaces that contact O-rings. Regularly clean the threads of the rotor (lid, handle, buckets, cavities, and so on) with a nonmetal brush and a small amount of concentrated detergent, then rinse, and dry thoroughly. Lubricate the threads as directed under LUBRICATION, below.

DECONTAMINATION

Rotors contaminated with radioactive or pathogenic materials must be decontaminated, following appropriate laboratory safety guidelines and/or other regulations.

NOTE

Strong bases and/or high-pH solutions can damage aluminum rotors and components.



- If a rotor (and/or accessories) becomes contaminated with radioactive material, it should be decontaminated using a solution that will not damage the anodized surfaces. Beckman Coulter has tested a number of solutions and found two that do not harm anodized aluminum: RadCon Surface Spray or IsoClean Solution (for soaking),¹ and Radiacwash.²

NOTE

IsoClean can cause fading of colored anodized surfaces. Use it only when necessary, and do not soak rotor components longer than the minimum time specified in the IsoClean usage instructions. Then remove it promptly from surfaces.

While Beckman Coulter has tested these methods and found that they do not damage components, no guarantee of decontamination is expressed or implied. Consult your laboratory safety officer regarding the proper decontamination methods to use.



- If the rotor or other components are contaminated with toxic or pathogenic materials, follow appropriate decontamination procedures as outlined by appropriate laboratory safety guidelines and/or other regulations. Consult Appendix A to select an agent that will not damage the rotor.

¹ In U.S., contact Nuclear Associates (New York); in Eastern Europe and Commonwealth States, contact Victoreen GmbH (Munich); in South Pacific, contact Gammasonics Pty. Ltd. (Australia); in Japan, contact Toyo Medic Co. Ltd. (Tokyo).

² In U.S., contact Biodex Medical Systems (Shirley, New York); internationally, contact the U.S. office to find the dealer closest to you.

STERILIZATION AND DISINFECTION

When sterilization or disinfection is a concern, consult your laboratory safety officer regarding proper methods to use. While Beckman Coulter has tested the following methods and found that they do not damage the rotor or components, no guarantee of sterility or disinfection is expressed or implied.

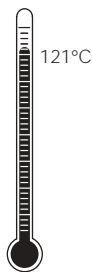

- Rotors and most rotor components (except those made of Noryl) can be autoclaved at 121°C for up to an hour. Remove the lid, bucket caps, or rotor plugs and place the rotor (and/or buckets) in the autoclave upside-down. (O-rings and gaskets can be left in place on the rotor.)
- Ethanol (70%)³ may be used on all rotor components, including those made of plastic. Bleach (sodium hypochlorite) may be used, but may cause discoloration of anodized surfaces. Use the minimum immersion time for each solution, per laboratory standards.

INSPECTION

Frequent and thorough inspection is crucial to maintaining a rotor in good operating condition.

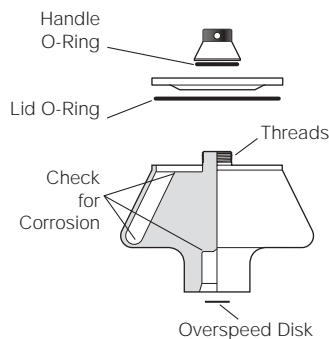

- Periodically (at least monthly, depending on use) inspect the rotor, especially inside cavities and buckets, for rough spots, cracks, pitting, white powder deposits on aluminum rotors (frequently aluminum oxide), or heavy discoloration. If any of these signs are evident, do not run the rotor. Contact your Beckman Coulter representative for information about the Field Rotor Inspection Program and the Rotor Repair Program.
- Regularly check the condition of O-rings or gaskets and replace any that are worn or damaged.
- Regularly check that all sealing surfaces are smooth and undamaged to ensure proper sealing.

³ Flammability hazard. Do not use in or near operating ultracentrifuges.

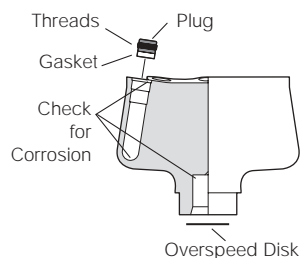

- Regularly check the condition of rotor plugs (a component of vertical tube and near vertical tube rotors) and rotor plug gaskets. Replace worn or damaged gaskets.
- Regularly inspect the overspeed disk. If it is scratched, damaged, or missing, replace it.

FIELD ROTOR INSPECTION PROGRAM

The Field Rotor Inspection Program (FRIP) has two purposes:

- to prevent premature rotor failures by detecting conditions such as stress, corrosion, metal fatigue, damage, or wear in the anodized coatings; and
- to instruct laboratory personnel in the proper care of rotors.

Beckman Coulter has trained a group of experienced service engineers in the techniques of nondestructive evaluation. For more information about the program, contact your Beckman Coulter representative.

LUBRICATION

Proper lubrication is essential to obtain specified torque values, where required, and to minimize thread wear.

- Many rotors use O-rings as seals to maintain atmospheric pressure in the rotor during a run. These O-rings and the surfaces they bear against must be kept clean and evenly lubricated. After removing and cleaning rotor O-rings or gaskets, lightly but evenly coat them with silicone vacuum grease (335148) and reposition them in the rotor.
- After cleaning metal threads, lubricate them with Spinkote lubricant (306812). *Failure to keep threads properly lubricated can result in stripped or galled threads and stuck rotor components.*
- Rotor plug gaskets (a component of vertical tube and near vertical tube rotors) do NOT require lubrication, but should be checked, cleaned, and or replaced as required.

OVERSPEED DISK REPLACEMENT

The overspeed disk on the rotor bottom is part of the photoelectric overspeed detection system. Replace this disk if it is scratched, damaged, or missing. Start with a dry rotor at room temperature—the disk will not adhere to a damp surface.

Centering
Tool
(331325)

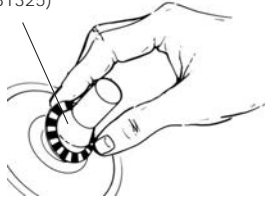

1. Pry up the edges of the old disk with a scalpel, taking care not to scratch the rotor, then peel the disk off
2. Clean the area around the drive hole with acetone to remove any of the old adhesive.
3. Insert the centering tool (331325) into the hole.
4. Peel the paper backing off the new disk, but do not touch the adhesive. Fit it, adhesive-side down, around the centering tool. Press the disk firmly to the rotor bottom.
5. Remove the tool. Allow the disk to set for a minimum of 2 hours.

TUBE, BOTTLE, AND ACCESSORY CARE

Proper care of tubes and bottles involves observing temperature, fill volume, and run speed limitations as well as careful cleaning and sterilization procedures.

CLEANING

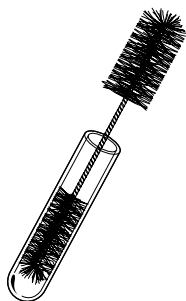

Do not wash tubes and bottles in a commercial dishwasher—detergents and temperatures are too harsh.

- Wash tubes, bottles, adapters, and other accessories by hand, using a mild detergent, such as Solution 555 (339555) diluted 10 to 1 with water, and a soft brush.
- Polycarbonate bottles and tubes are vulnerable to attack by alkaline solutions and detergents, so use a detergent with pH less than 9, such as Solution 555. Do not use a brush with exposed metal; scratches in polycarbonate will cause early failure.

- Alcohol and acetone react unsatisfactorily with many tube and accessory materials. If a solvent must be used to rinse, dry, or decontaminate these materials, consult Appendix A to select an appropriate solvent.
- Do not dry tubes, bottles, or accessories in an oven. Labware should be air-dried.
- OptiSeal, Quick-Seal, Ultra-Clear, and thinwall polyallomer tubes are intended for one-time use and should be discarded after use.

DECONTAMINATION



Labware contaminated with radioactive or pathogenic solutions should be decontaminated or disposed of following appropriate safety guidelines and/or regulations. Consult Appendix A to select an agent that will not damage the tube or bottle material.

STERILIZATION AND DISINFECTION

Refer to Table 7-1 for sterilization methods recommended for each container type.

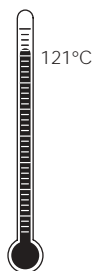

Most tubes and accessories, *except those made of Ultra-Clear, polyethylene, Noryl, or cellulose propionate*, can be autoclaved at 121°C for about 20 minutes. Note that autoclaving reduces the lifetime of polycarbonate tubes. Also, polyallomer tubes may be permanently deformed if they are autoclaved many times or if they are handled or compressed before they cool. Tubes and bottles should be placed open-end down or supported in a rack if autoclaved. Do not autoclave plastic adapters or spacers.



CAUTION

Do not autoclave tubes or bottles with caps on. Pressure in a sealed container can cause an explosion. Pressures within the autoclave can cause partially sealed containers to collapse when the autoclave vents.

Table 7-1. Tube and Bottle Sterilization and Disinfection.
 This information is provided as a guide to the use of sterilization and disinfection techniques for tube materials. Cold sterilization results shown are for short-duration (10-minute) soak periods; reactions may differ with extended contact. Refer to Appendix A of this manual for information about specific solutions.

Tube/Bottle Material	Autoclave ¹ (121°C)	UV Irradiation	Ethylene Oxide	Formaldehyde	Ethanol (70%) ²	Sodium Hypochlorite (10%)	Hydrogen Peroxide (10%)	Glutaraldehyde (2%)	Phenolic Derivatives
polyallomer	yes	no	yes	yes	yes	yes	yes	yes	no
Ultra-Clear	no	no	yes	yes ³	yes	yes	yes	yes	no
polycarbonate	yes ⁴	no	yes	yes ³	no	yes ⁵	yes	yes	no
polypropylene	yes	no	yes	yes	yes	yes ⁶	yes ⁷	yes	no
polyethylene	no	no	yes	yes	yes ⁸	yes	yes	yes	yes
cellulose propionate	no	no	no	no	no	yes	yes	yes	no
stainless steel	yes	yes	yes	yes	yes ⁹	no	yes	yes	no

¹ To avoid deformation, autoclave tubes or bottles open-end down in a tube rack at 15 psig for no more than 20 minutes (allow to cool before removing from tube rack). DO NOT autoclave capped or sealed tubes or bottles.

² Flammable; do not use in or near operating ultracentrifuges.

³ Do not use if there is methanol in the formula.

⁴ Tube life will be reduced by autoclaving.

⁵ Discoloration may occur.

⁶ Can be used if diluted.

⁷ Below 26°C only.

⁸ Below 21°C only.

⁹ Marginal.

A cold sterilization method, such as immersion in 10% hydrogen peroxide for 30 minutes, may be used on Ultra-Clear tubes. Refer to Table 7-1 to select cold sterilization materials that will not damage tubes and accessories.

While Beckman Coulter has tested these methods and found that they do not damage the components, no guarantee of sterility or disinfection is expressed or implied. When sterilization or disinfection is a concern, consult your laboratory safety officer regarding proper methods to use.

INSPECTION

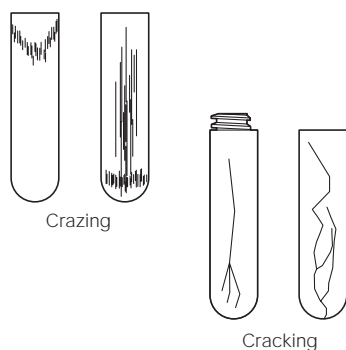

Inspect containers and accessories before use.

- Inspect tubes and bottles for cracks or any major deformities before using them.
- Do not use a tube that has become yellowed or brittle with age or excess exposure to ultraviolet light.
- Crazing—the appearance of fine cracks on tubes and bottles—is the result of stress relaxation. If a crack approaches the outer wall of the tube or bottle, discard it.
- Discard any deformed or cracked adapters.

TUBE AND BOTTLE STORAGE

Tubes and bottles have an indefinite shelf life if properly stored. Store in a dark, cool, dry place away from ozone, chemical fumes, and ultraviolet light sources.

REMOVING JAMMED OR COLLAPSED TUBES

Centrifugal force may collapse improperly sealed or capped thinwall tubes. Observe careful filling and capping procedures to prevent tube collapse.

NOTE

Centrifugation often causes a slight vacuum to build up in the tube cavity, occasionally resulting in a suction effect when removing the tubes from the rotor. This effect is especially pronounced in a rotor that has been centrifuged at low temperature. A brief delay (approximately 5 minutes) after the rotor comes to rest before removing the tubes can make tube removal easier. If tubes are difficult to remove from the rotor, use a gentle twisting or rocking motion, and remove the tube slowly to avoid sample mixing.

If a tube is jammed or collapsed in the rotor, try one of the following techniques, but DO NOT force the tube. Contact your Beckman Coulter Service representative if you are unsuccessful.



CAUTION

Do not use a hemostat or any metal tool to pry a jammed or collapsed tube out of the rotor. The rotor can be scratched and damaged.

- If an uncapped polycarbonate tube is stuck, remove tube contents and place the rotor or bucket upside-down in an autoclave for about 30 to 60 minutes. When the rotor is cool enough to handle, try to remove the jammed or collapsed tube. *Do not autoclave sealed or capped tubes or bottles.*
- Pour a solvent in the tube to make the tube material more flexible. Several changes of solvent may be necessary to weaken the tube for easy removal. Refer to the chemical resistances list in Appendix A to select a solvent that will not damage the rotor.

TUBE CAP CARE

It is very important to keep tube-cap assemblies together as a unit. Do NOT interchange cap components; caps are designed as a unit for a particular tube being centrifuged in a particular rotor. If cap components are separated for cleaning, be sure components are classified according to the tube and rotor for which they are designed. Do not store O-rings or gaskets under compression.

CLEANING



1. Disassemble tube caps and wash them in a mild detergent solution, such as Beckman Solution 555 (339555), diluted 10 to 1 with water. If necessary, scrub the inside of caps using a cotton-tipped swab or a brush that will not scratch the surface.

NOTE

Do not soak aluminum cap parts in a strong detergent solution, as the anodizing may be attacked.

2. Clean the nut and stem threads regularly with concentrated Solution 555 and a brush.
3. Rinse all parts in distilled water and dry them.
4. Apply a thin, even coat of Spinkote lubricant (306812) to the stem threads.
5. Wipe O-rings and gaskets clean with a tissue. *Do not lubricate O-rings or gaskets.*

DECONTAMINATION

- If the tube caps become contaminated with radioactive material, decontaminate them using a solution that will not damage the anodized surfaces. Beckman Coulter has tested a number of solutions and found two that do not harm anodized aluminum: RadCon Surface Spray or IsoClean Solution (for soaking),⁴ and Radiacwash.⁵

NOTE

IsoClean can cause fading of colored anodized surfaces. Use it only when necessary and remove it promptly from surfaces.

While Beckman Coulter has tested these methods and found that they do not damage components, no guarantee of sterility or disinfection is expressed or implied. Consult your laboratory safety officer regarding the proper decontamination methods to use.

⁴ In U.S., contact Nuclear Associates (New York); in Eastern Europe and Commonwealth States, contact Victoreen GmbH (Munich); in South Pacific, contact Gammasonics Pty. Ltd. (Australia); in Japan, contact Toyo Medic Co. Ltd. (Tokyo).

⁵ In U.S., contact Biodex Medical Systems (Shirley, New York); internationally, contact the U.S. office to find the dealer closest to you.



- If tube caps are contaminated with toxic or pathogenic solutions, decontaminate or dispose of them as directed by your laboratory safety officer, following appropriate safety guidelines. Check the chemical resistances list in Appendix A to be sure the decontamination method will not damage any part of the rotor.

STERILIZATION AND DISINFECTION

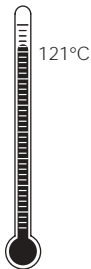

- All cap components (except those made of Noryl) can be autoclaved at 121°C for up to 30 minutes. Disassemble caps for autoclaving.
- Ethanol (70%)⁶ or hydrogen peroxide (6%) may be used on cap components, including those made of plastic. Bleach (sodium hypochlorite) may be used, but may cause discoloration of anodized surfaces. Use the minimum immersion time for each solution, per laboratory standards.

While Beckman Coulter has tested these methods and found that they do not damage components, no guarantee of sterility or disinfection is expressed or implied. When sterilization or disinfection is a concern, consult your laboratory safety officer regarding proper methods to use.

LUBRICATION

- Keep the stem threads lightly lubricated with Spinkote lubricant (306812). Clean, lubricated threads can be fully tightened without galling or seizing.
- The O-ring or gasket must be used dry and *without lubrication*. A wet or greased O-ring or gasket may allow the stem to rotate when the cap nut is tightened, preventing proper sealing of the cap.

⁶ Flammability hazard. Do not use in or near operating ultracentrifuges.

INSPECTION

Inspect tube-cap components before each use. Refer to Table 3-4 in Section 3 of this manual for a list of cap components.

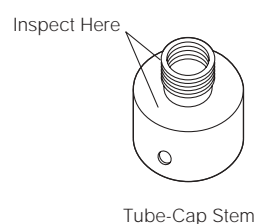
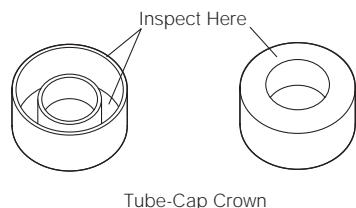

- Carefully inspect the crown for deformed or roughened edges. Run your finger around the bottom edge of the crown; surfaces should be flat, squared-off, and not rounded or jagged. Check the top of the crown and the base of the O-ring groove for fine, circular lines or stress cracks. (Do not use damaged wrenches or hex drivers or tools that have burrs. A burred tool can score the crown.) Discard a damaged crown, as it may fail and damage the rotor.
- Inspect the cap stem for evidence of stress cracking. Also, make sure that threads are in good condition and properly lubricated before use. Look at the underside of the stem; the white nylon insert should not protrude below the filling hole. If it does, replace the nylon insert (see replacement procedures below).
- Check the O-ring or gasket for cuts, excessive abrasions, or flattened areas. It is good practice to replace the O-ring or gasket frequently.
- On caps with filling holes, inspect the filling hole setscrew and threads. If the hex cavity in the setscrew shows signs of wear, replace the setscrew.

NYLON INSERT REPLACEMENT

The nylon insert fits into the cap stem and can become worn or loose with continued cap use. If the insert is worn, the setscrew will no longer seal the cap and it should be replaced.

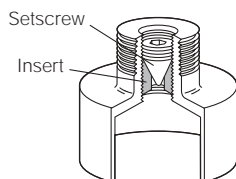

1. Remove the cap setscrew and fit the nylon insert tool (302460) firmly into the stem.
2. Unscrew the insert.
3. Fit a new insert (302312) on the end of the tool and screw it into the stem until it bottoms firmly against the stem threads.

RETURNING A ROTOR OR ACCESSORY TO THE FACTORY

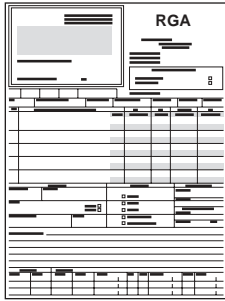

Before returning a rotor or accessory for any reason, prior permission (a Returned Goods Authorization form) must be obtained from Beckman Coulter, Inc. This RGA form may be obtained from your local Sales Office. It should contain the following information:

- serial number,
- history of use (approximate frequency of use),
- reason for the return,
- original purchase order number, billing number, and shipping number, if possible,
- name and phone number of the person to be notified upon receipt of the rotor or accessory at the factory, and
- name and phone number of the person to be notified about repair costs, etc.

To protect our personnel, it is the customer's responsibility to ensure that the parts are free from pathogens, chemical hazards, and/or radioactivity. Sterilization and decontamination **MUST** be done before returning the parts. Smaller items (such as tubes, bottles, and so on) should be enclosed in a sealed plastic bag.

*All parts must be accompanied by a note, plainly visible on the outside of the box or bag, stating that they are safe to handle and that they are not contaminated with pathogens, chemical hazards, or radioactivity. **Failure to attach this notification will result in return or disposal of the items without review of the reported problem.***

Use the address label printed on the RGA form when mailing the rotor and/or accessories to:

Beckman Coulter, Inc.
Spinco Business Center
1050 Page Mill Road
Palo Alto, CA 94304

Attention: Returned Goods

Customers located outside the United States should contact their local Beckman Coulter office.

DIAGNOSTIC HINTS

Some of the more common operating problems experienced in centrifugation are listed below with suggestions for their solutions. Contact Beckman Coulter Field Service if a problem cannot be corrected.

NOTE

Use only the labware listed in the applicable rotor manual.

SYMPTOM	POSSIBLE CAUSE AND SUGGESTED ACTION
Rotors	
Severe vibration	<ul style="list-style-type: none"> • Rotor imbalance. To balance the rotor load, fill all opposing tubes to the same level with liquid of the same density. Weight of opposing tubes must be distributed equally. Place tubes in a fixed angle, near vertical tube, or vertical tube rotor symmetrically, as illustrated in Section 1 (Figure 1-6). • Swinging bucket rotor — Mishooked bucket, loose bucket cap, wrong type of bucket, mixed bucket types, opposing buckets not filled to the same level with liquids of the same density. Check loading procedures (refer to Section 5).
Stripped rotor plugs on vertical tube or near vertical tube rotors	Rotor vise not used, wrong tool used, incorrect torque, or insufficient pressure on plug adapter, when tightening rotor plugs. Observe careful tightening procedures.
Rotor lid is difficult to remove after centrifugation	Threads contaminated with dirt, dried lubricant, or metal particles, or threads insufficiently lubricated cause rotor components to stick. Do not use excessive force to loosen components. Contact your Beckman Coulter representative. Routinely clean metal threads with concentrated Solution 555 (339555), then lubricate them with Spinkote (306812).
Paint coming off where bucket contacts rotor pocket on swinging bucket rotor	Not an operational problem.

SYMPTOM	POSSIBLE CAUSE AND SUGGESTED ACTION
Tubes	
Tube leakage	
Tubes with cap assemblies	<ul style="list-style-type: none"> • Caps not properly secured. Caps must be properly seated on tubes and then fully tightened. • Cap components not dry before assembly. Thoroughly dry all components before assembling. • The setscrew may not be sealing the filling hole. The nylon insert may have been driven out by the filling hole setscrew. Check hex cavity. If the threads of the screw are stripped, replace the screw. It may be necessary to replace the stem also. The interface between the setscrew and the nylon insert is critical. Refer to insert replacement procedures in this section. • Insufficient liquid in tube. Observe minimum fill volumes.
Tubes with snap-on caps	Tube too full; the meniscus must be kept lower to prevent leakage.
Uncapped tubes	Tube volume exceeds maximum uncapped volume. Refer to the rotor manual for tube volumes and speed reductions.
OptiSeal tubes	Improperly plugged. Make sure that no fluid is trapped in the tube stem, and that the stem is clean and dry before inserting plug. (Refer to publication IN-189 for instructions on filling and plugging OptiSeal tubes.)
Quick-Seal tubes	Improperly sealed. After heat-sealing, squeeze the tube gently (if the tube contents may be disturbed) to test the seal for leaks. If the tube leaks, reseal it.
Tube cracking	<ul style="list-style-type: none"> • Tubes may crack or become brittle if they are used below their lower temperature limit. Before using tubes at other than stated temperature limits, evaluate them under centrifugation conditions. If sample is frozen in tubes, make sure that tubes are thawed to at least 2°C before centrifugation. • Tubes may become brittle with age and use. Dispose of brittle or cracked tubes.
Tube collapse	<ul style="list-style-type: none"> • Thinwall tube volume too low to provide tube wall support. Meniscus should be 2 to 3 mm below the tube top. Refer to the rotor manual for tube volumes. • Moisture between the tube and the cavity or bucket can cause the tube to float and collapse. Ensure that tubes and tube cavities or buckets are dry before inserting the tubes. • Reagent used that attacks the tube material. Refer to Appendix A for chemical compatibilities of tube material and chemicals. • Tubes run above their rated speed. Refer to the applicable rotor manual for maximum speeds.

SYMPTOM	POSSIBLE CAUSE AND SUGGESTED ACTION
Tube Caps	
Unsure of cap components	For a complete list of cap components, see the Beckman Coulter <i>Ultracentrifuge Rotors, Tubes & Accessories</i> catalog (publication BR-8101), available at www.beckmancoulter.com .
Setscrew is difficult to remove	The hex socket or threads of the screw may be stripped. If the screw cannot be removed, replace the cap stem.
Setscrew will not seal the tube cap	Replace the screw and nylon insert if either seems damaged or loose.
Bottles	
Bottle leakage (bottles with cap assemblies)	<ul style="list-style-type: none"> • Moisture or lubrication on cap or sealing surface. Ensure that the O-ring, plug, and bottle lip are dry and free of lubrication before use. • O-ring or gasket damaged or defective. Replace the O-ring or gasket. • Cap not tightened sufficiently. Tighten cap securely. • Sealing surface of the bottle is not smooth. Replace bottle.
Bottle leakage (uncapped bottles)	Bottle too full; the meniscus must be kept lower to prevent leakage. Refer to the rotor manual for fill volumes and speed reductions.
Bottle damage	<ul style="list-style-type: none"> • Fill volume too low to provide tube wall support. Refer to the rotor manual for fill volumes and speed reduction. • Moisture between the bottle and the cavity or bucket can cause the bottle to float and collapse. Ensure that bottles and cavities or buckets are dry before inserting them. • Reagent used that attacks the bottle material. Refer to Appendix A for chemical compatibilities of bottle material and chemicals. • Bottles may crack or become brittle if they are used below their lower temperature limit. Before using bottles at other than stated temperature limits, evaluate them under centrifugation conditions. If sample is frozen in bottles, make sure that bottles are thawed to at least 2°C before centrifugation. • Bottles may become brittle with age and use. Dispose of brittle or cracked bottles. • Improper cleaning, decontamination, or sterilization procedures used. Refer to Table 7-1 for acceptable procedures and materials.

Chemical Resistances for Beckman Coulter Centrifugation Products

To Close *Rotors and Tubes*
and Open the *Chemical Resistances Chart*

[Click Here](#)

Use of the ω^2t Integrator

The centrifugal force applied to a sample in a spinning rotor is shown by ω^2r , where r is the radial distance from the axis of rotation and ω is the angular velocity in radians per second ($\omega = 2\pi \text{ rpm}/60$). The sedimentation velocity (dr/dt) is proportional to the centrifugal force; the velocity of a sedimenting particle increases as it moves outward in the tube. Thus, a force-corrected velocity is used to describe the movement of particles under centrifugal force. This is the sedimentation coefficient s , defined as the sedimentation velocity per unit of centrifugal force:

$$s = \frac{dr}{dt} \times \frac{1}{\omega^2r} \quad (\text{B-12})$$

The integrated form of the equation is:

$$s = \frac{\ln\left(\frac{r_2}{r_1}\right)}{\omega^2t} \quad (\text{B-13})$$

where r_1 is the initial position of the particle and r_2 is the final position, relative to the axis of rotation. These distances can be readily determined. However, an accurate measure of the centrifugal force applied to the particle necessitates that the value of ω generated during periods of changing speed be calculated, that is from the time when the rotor starts spinning (t_1) until the rotor stops (t_2). The ω^2t integrator automatically computes the total centrifugal effect—during acceleration, constant speed operation, speed changes, and deceleration—and displays this as a continuously updated value of

$$\int_{t_1}^{t_2} \omega^2 dt \quad (\text{B-14})$$

There are two kinds of experiments in which the integrator is particularly useful: duplicating conditions in a series of rate runs, and calculating sedimentation coefficients for rate zonal studies. To duplicate band positions, use the integrator to automatically terminate the run at a preselected value of ω^2t . In this way, even if the set run speed or acceleration is changed for a rotor, band positions will be reproducible. For determining sedimentation coefficients, the value of ω^2t displayed on the integrator at the termination of the run greatly simplifies the arithmetic involved and improves the final result.

The $s\omega^2t$ charts for density gradient experiments in swinging bucket rotors (provided in publication DS-528) are plots of the relative distance sedimented by a band of particles versus the value of $s\omega^2t$. They have been calculated for use with 5 to 20% or 10 to 30% (wt/wt) sucrose gradients, particle densities of 1.4 and 1.8 g/mL, and temperatures of 4 and 20°C. The following examples illustrate the use of the charts together with the ω^2t integrator.

REPRODUCING BAND POSITIONS (refer to Figure B-1)

To achieve the best resolution of particle zones, the centrifugation duration should be set so that the fastest moving zone of particles will move as close as practical to the bottom of the gradient. To determine the centrifugation duration, the following must be known: an estimate of the sedimentation coefficient of the particle of interest, the distance from the axis of rotation it is to travel, its density, and certain properties of the gradient. For example, to position a protein sample characterized by s of 7×10^{-13} seconds (or 7 S) and density of 1.4 g/mL 37 mm down the length of the centrifuge tube in the SW 60 Ti rotor (37 + 63 mm,¹ or 100 mm from the axis of rotation) through a 10 to 30% gradient at 20°C, the value of $s\omega^2t$ must be 0.92 (from the figure).

If the value of $s\omega^2t$ is divided by s , the result is the total centrifugal effect.

$$\begin{aligned}\omega^2t &= \frac{0.92}{7 \times 10^{-13}} && \text{(B-15)} \\ &= \frac{1.31 \times 10^{12} \text{ rad}^2}{s}\end{aligned}$$

¹ The radial distance to the tube meniscus in the SW 60 Ti rotor is 63 mm.

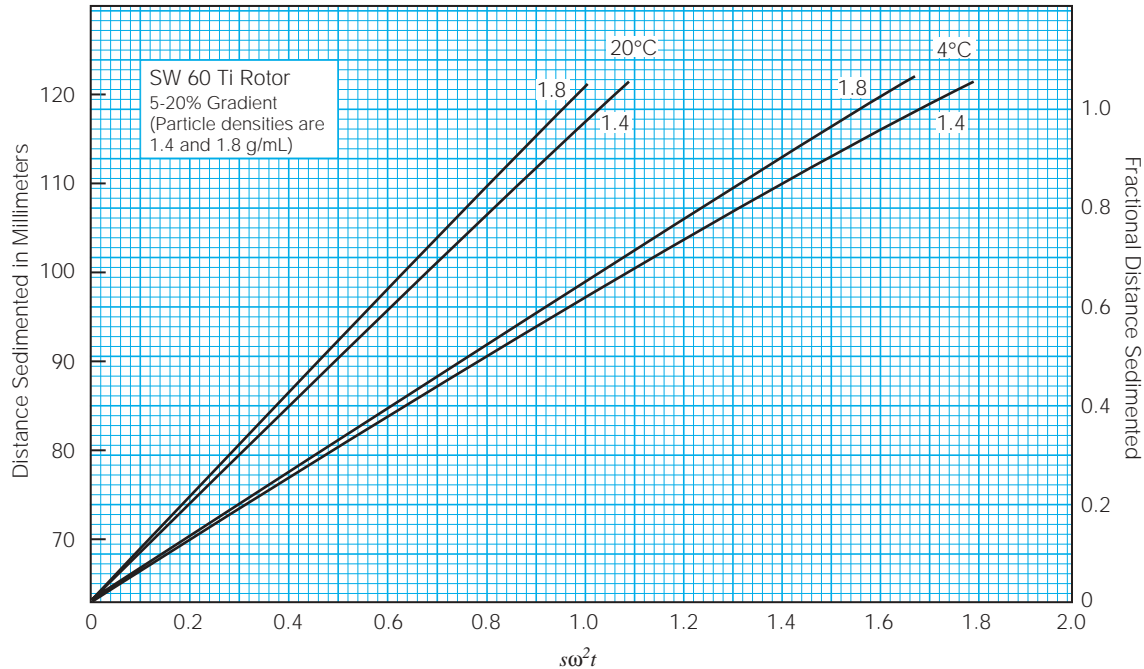
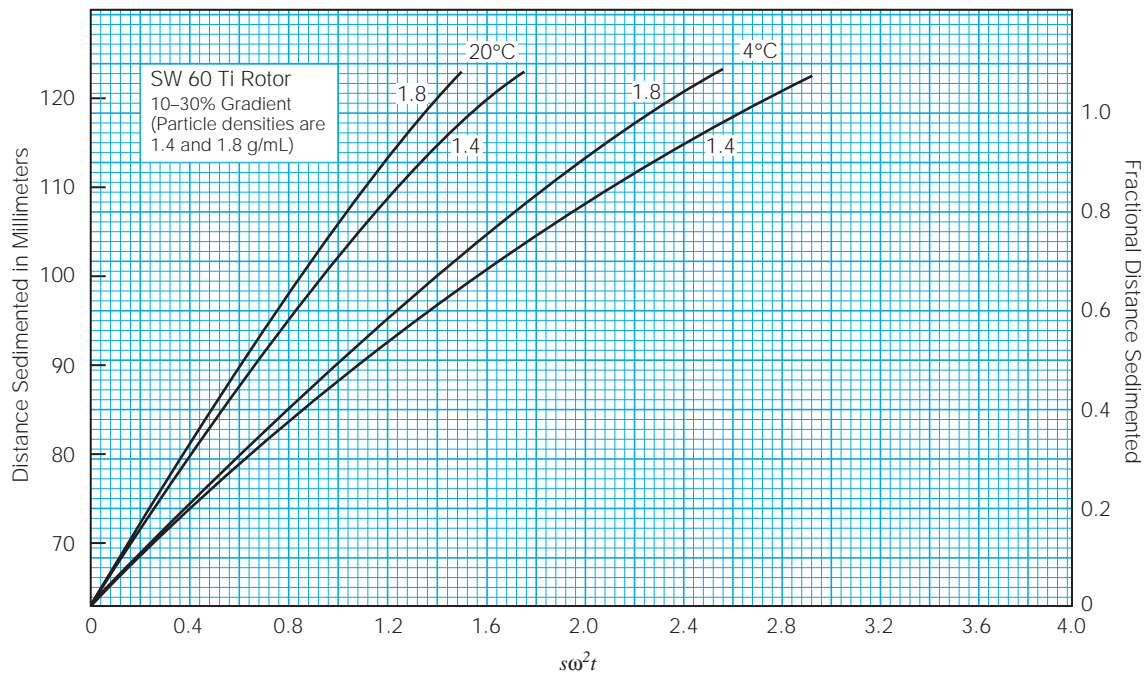

Figure B-1. The $s\omega^2t$ Charts for the SW 60 Ti Rotor

This value can be set into the integrator, and the integrator used to terminate the run when this value is reached. Because of deceleration, however, this value of ω^2t will actually be a little too much. For a more exact approximation, you should make a trial run with an empty rotor and measure the value of ω^2t that accumulates during deceleration from run speed, then subtract that value from the total determined from the charts.

CALCULATING SEDIMENTATION COEFFICIENTS

To calculate sedimentation coefficients, the following must be known: particle density, the distance from the axis of rotation it is to travel, specific properties of the gradient, run speed, and centrifugation time. The value of ω^2t is used in place of run speed and time. For example, if a protein of density 1.4 g/mL travels 37 mm down the length of the tube in the SW 60 Ti rotor (37 + 63 mm, or 100 mm from the axis of rotation) through a 10 to 30% gradient at 20°C, the value of $s\omega^2t$ is 0.92 (from the figure). By dividing the value of $s\omega^2t$ by the product ω^2t (from the integrator), the result is the sedimentation coefficient, in seconds, of the particle:

$$s = \frac{0.92}{\omega^2t} \quad (\text{B-16})$$

The Use of Cesium Chloride Curves

This Appendix describes how to determine a maximum rotor speed and the final band positions of particles when performing isopycnic separations using cesium chloride gradients. The examples shown here are for the Type 90 Ti rotor only. Similar data and examples for other rotors appear in the applicable rotor manual shipped with each rotor. Be sure to check the manual for your rotor when calculating run speeds and banding positions.

Rotor speed controls the slope (dp/dr) of a CsCl equilibrium gradient. When planning a separation, gradients should be selected so that the density range from the top to the bottom of the gradient is sufficient to encompass the buoyant densities of particles to be separated. However, speeds must often be limited to avoid precipitation of CsCl at the bottom of the gradient. The density of crystallized CsCl (4 g/mL) produces stresses far in excess of the design limits of most rotors. Also, precipitation will alter the density distribution of the gradient, and the position of sample bands.

The square-root reduction formula—used to determine maximum rotor speeds when centrifuging dense solutions in plastic tubes—does not always guard against CsCl precipitation. The square-root reduction becomes the limiting factor only at relatively high densities and speeds.

Speed and density combinations that intersect on or below the solid curves in Figure C-1 ensure that CsCl will not precipitate in the Type 90 Ti rotor. Curves are provided at two temperatures: 20°C (black lines) and 4°C (gray lines). Note from Figure C-1 that for a given CsCl density, faster rotor speeds can be used as the fill volume in the tube decreases from full to one-quarter filled. Also, for a given rotor speed, the maximum CsCl density that can be safely centrifuged at that speed and temperature increases as the fill volume decreases.

The curves in Figure C-2 show gradient profiles *at equilibrium*. Each curve was generated for the specific rotor speed shown using the maximum CsCl density (from Figure C-1) that avoids precipitation at

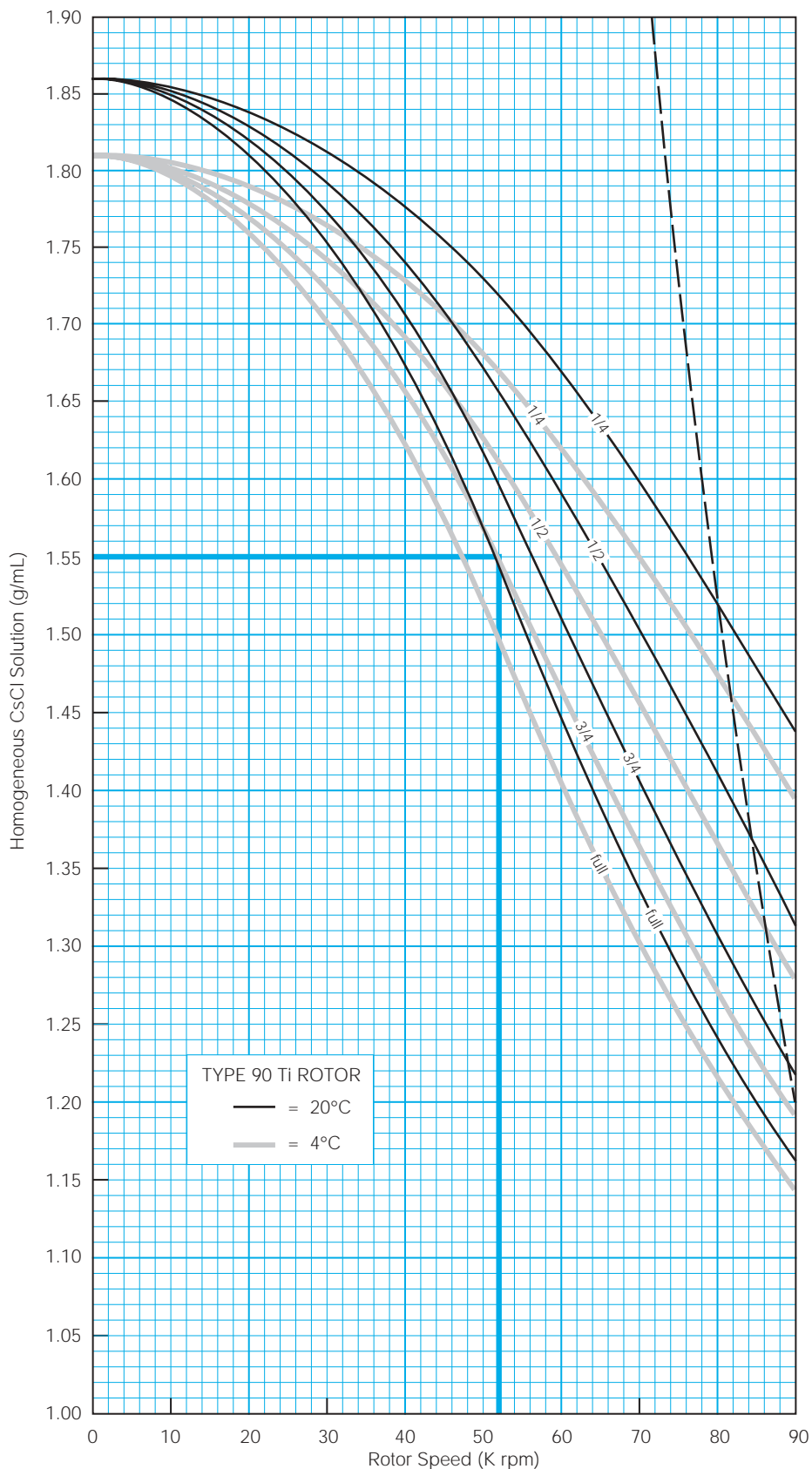

The dashed line is a representation of the equation:

$$\text{RPM} = 90\,000 \sqrt{\frac{1.2 \text{ g/mL}}{\rho}}$$

where ρ = density of tube contents

and is shown here to illustrate the inability of that equation to guard against CsCl precipitation.

Figure C-1. Precipitation Curves for the Type 90 Ti Rotor. Using combinations of rotor speeds and homogeneous CsCl solution densities that intersect on or below these curves ensures that CsCl will not precipitate during centrifugation.

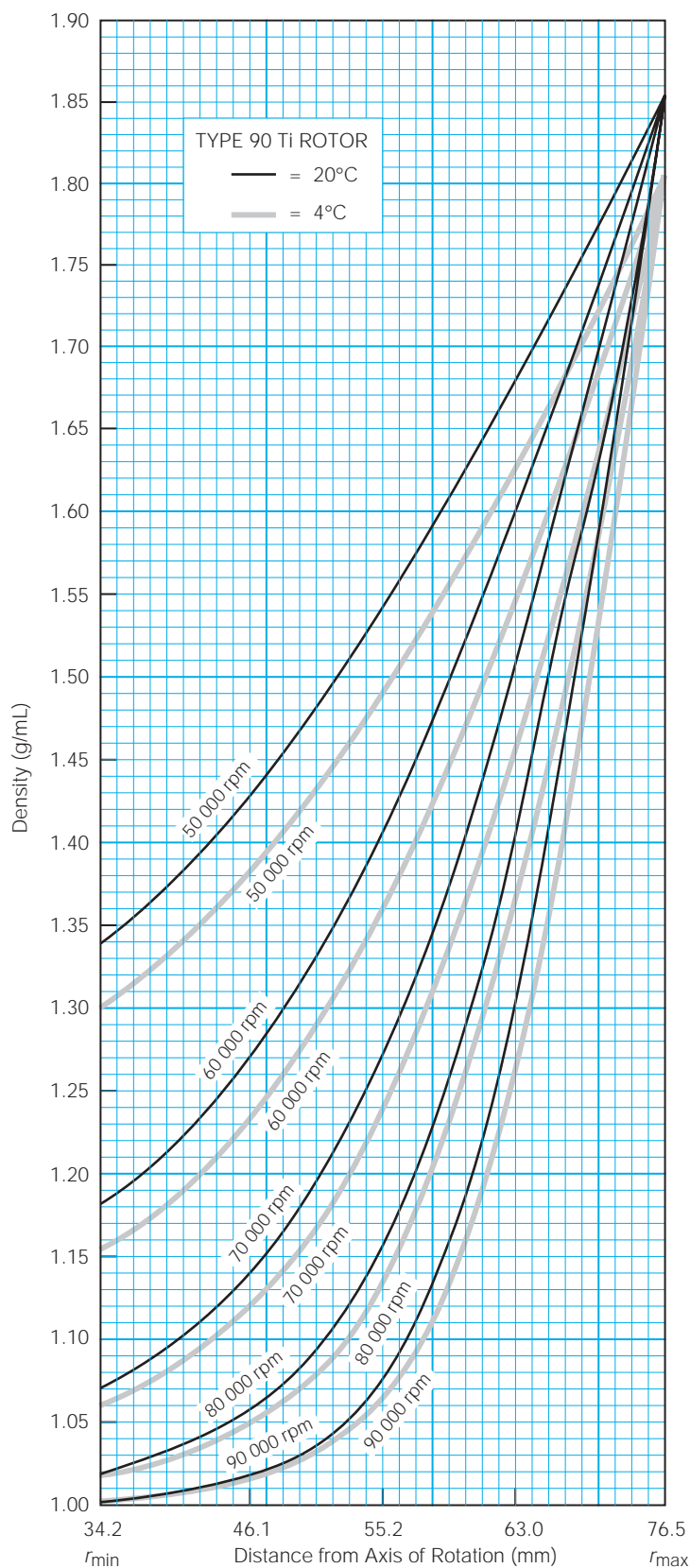

Figure C-2. CsCl Gradients at Equilibrium. Centrifugation of homogeneous CsCl solutions at the maximum allowable speeds (from Figure C-1) results in gradients presented here. Density increases from the top (34.2 mm) to the bottom (76.5 mm) of the tube.

that speed and temperature.¹ The three-quarter-, one-half-, and one-quarter-filled lines show gradients produced in partially filled tubes. Figure C-2 can be used to approximate banding positions of sample particles. In general, lower speeds generate gradients with shallow slopes; bands will be farther apart. Higher speeds generate gradients with steep slopes where bands will be closer together. Gradient curves not shown can be interpolated.

NOTE

The curves in Figures C-1 and C-2 are for solutions of CsCl salt only. If other salts are present in significant concentrations, the overall CsCl concentration or the rotor speed must be reduced.

For example, a quarter-filled tube of a 1.52 g/mL homogeneous CsCl solution at 20°C may be centrifuged at 80 000 rpm (see Figure C-1). The segment of the 80 000 rpm curve (Figure C-2) from the quarter-filled line to 1.86 g/mL at the tube bottom represents this gradient. The same solution in a half-filled tube (Figure C-1) may be centrifuged no faster than 68 000 rpm.

Using Figure C-2, interpolate between the 60 000 rpm and 70 000 rpm curves and draw the new 68 000 rpm gradient curve to the half-filled level. The same solution in a three-quarter-filled tube may be centrifuged at 59 000 rpm; Figure C-2 shows the gradient profile (use the three-quarter-filled segment only). A tube *full* of the 1.52 g/mL CsCl solution may be centrifuged no faster than 53 000 rpm (interpolate and draw in the new gradient profile).

TYPICAL EXAMPLES FOR DETERMINING CsCl RUN PARAMETERS

Example A: A separation that is done frequently is the banding of plasmid DNA in cesium chloride with ethidium bromide. The starting density of the CsCl solution is 1.55 g/mL. In this separation the covalently closed, circular plasmid bands at a density of 1.57 g/mL, while the nicked and linear species band at 1.53 g/mL. At 20°C, where will particles band?

¹ Gradients in Figure C-2 result from homogeneous CsCl solutions, but can be more rapidly generated from step or linear gradients, as long as the total amount of CsCl in solution is equal to the amount in the homogeneous solution from the curves in Figure C-1.

1. In Figure C-1, find the curve that corresponds to the desired run temperature (20°) and tube fill volume (full). The maximum allowable rotor speed is determined from the point where this curve intersects the homogeneous CsCl density (52 000 rpm).
2. In Figure C-2, sketch a horizontal line corresponding to each particle's buoyant density.
3. Mark the point where each density intersects the curve corresponding to the maximum speed and selected temperature.
4. Particles will band at these points along the tube axis.

In this example, particles will band at about 55.2 and 58.1 mm from the axis of rotation (about 2.9 mm of interband [center-of-band to center-of-band] separation at the 25-degree tube angle). When the tube is held upright, there will be about 3.2 mm of interband separation.

NOTE

In swinging bucket rotors, the interband separation after centrifugation is the same as during centrifugation, as there is no gradient reorientation. In fixed angle, near vertical tube, and vertical tube rotors, the gradient must reorient to a horizontal position after centrifugation. Therefore, to determine the interband separation after centrifugation when the tube is held upright (d_{up}) use:

$$d_{\text{up}} = \frac{d_{\theta}}{\cos \theta} \quad (\text{C-17})$$

where d_{θ} is the interband separation achieved during centrifugation, and θ is the tube angle.

Example B: Knowing particle densities (1.50 and 1.52 g/mL), how do you achieve good separation?

1. In Figure C-2, sketch in a horizontal line corresponding to each particle's buoyant density.
2. Select the curve at the desired temperature (4°C) and tube volume (full) that gives good separation.
3. Note the speed indicated along the curve (50 000 rpm).

4. From Figure C-1, determine the maximum allowable homogeneous CsCl density that corresponds to the selected temperature, speed, and fill volume from Figure C-2 (in this case 1.51 g/mL).

In this example, particles will band at about 56 and 58 mm from the axis of rotation (about 2 mm of interband separation at the tube angle). When the tube is held upright, there will be about 2.21 mm of interband separation.

To determine the interband volume in millimeters, use:

$$V = \pi r^2 h \quad (\text{C-18})$$

where r is the tube radius in centimeters and h is the interband separation in centimeters.

Appendix D

Gradient Materials

This Appendix contains reference information on commonly used gradient materials. General instructions for filling and sealing tubes, including gradient preparation, are contained in Section 3.

Gradient material selection depends on a number of factors, including the type of separation to be performed. Sucrose is used for rate zonal and isopycnic separations, and cesium chloride is often used for isopycnic separations. The basic requirement is that the gradient permit the type of separation. Additional considerations in selecting a gradient material include the following.

- Its density range should be sufficient to permit separation of the particles of interest by the chosen density gradient technique, without overstressing the rotor.
- It should not affect the biological activity of the sample.
- It should be neither hyperosmotic or hypoosmotic when the sample is composed of sensitive organelles.
- It should not interfere with the assay technique.
- It should be removable from the purified product.
- It should not absorb in the ultraviolet or visible range.
- It should be inexpensive and readily available; more expensive materials should be recoverable for reuse.
- It should be sterilizable.
- It should not be corrosive to the rotor.
- It should not be flammable or toxic to the extent that its aerosols could be hazardous.

The following charts are provided as a reference for information on commonly used gradient materials.

*Table D-1. Commonly Used Gradient Materials
with Their Solvents*

Materials	Solvent	Maximum Density at 20°C
Sucrose (66%)	H ₂ O	1.32
Sucrose (65%)	D ₂ O	1.37
Silica sols	H ₂ O	1.30
Diodon	H ₂ O	1.37
Glycerol	H ₂ O	1.26
Cesium chloride	H ₂ O	1.91
	D ₂ O	1.98
Cesium formate	H ₂ O	2.10
Cesium acetate	H ₂ O	2.00
Rubidium chloride	H ₂ O	1.49
Rubidium formate	H ₂ O	1.85
Rubidium bromide	H ₂ O	1.63
Potassium acetate	H ₂ O	1.41
Potassium formate	H ₂ O	1.57
	D ₂ O	1.63
Sodium formate	H ₂ O	1.32
	D ₂ O	1.40
Lithium bromide	H ₂ O	1.83
Lithium chloride	D ₂ O	1.33
Albumin	H ₂ O	1.35
Sorbitol	H ₂ O	1.39
Ficoll	H ₂ O	1.17
Metrizamide	H ₂ O	1.46

Table D-2. Density, Refractive Index, and Concentration Data—Cesium Chloride at 25°C, Molecular Weight = 168.37

Density (g/cm ³)*	Refractive Index, η_D	% by Weight	mg/mL of Solution [†]	Molarity	Density (g/cm ³)*	Refractive Index, η_D	% by Weight	mg/mL of Solution [†]	Molarity
1.0047	1.3333	1	10.0	0.056	1.336	1.3657	34	454.2	2.698
1.0125	1.3340	2	20.2	0.119	1.3496	1.3670	35	472.4	2.806
1.0204	1.3348	3	30.6	0.182	1.363	1.3683	36	490.7	2.914
1.0284	1.3356	4	41.1	0.244	1.377	1.3696	37	509.5	3.026
1.0365	1.3364	5	51.8	0.308	1.391	1.3709	38	528.6	3.140
1.0447	1.3372	6	62.8	0.373	1.406	1.3722	39	548.3	3.257
1.0531	1.3380	7	73.7	0.438	1.4196	1.3735	40	567.8	3.372
1.0615	1.3388	8	84.9	0.504	1.435	1.3750	41	588.4	3.495
1.0700	1.3397	9	96.3	0.572	1.450	1.3764	42	609.0	3.617
1.0788	1.3405	10	107.9	0.641	1.465	1.3778	43	630.0	3.742
1.0877	1.3414	11	119.6	0.710	1.481	1.3792	44	651.6	3.870
1.0967	1.3423	12	131.6	0.782	1.4969	1.3807	45	673.6	4.001
1.1059	1.3432	13	143.8	0.854	1.513	1.3822	46	696.0	4.134
1.1151	1.3441	14	156.1	0.927	1.529	1.3837	47	718.6	4.268
1.1245	1.3450	15	168.7	1.002	1.546	1.3852	48	742.1	4.408
1.1340	1.3459	16	181.4	1.077	1.564	1.3868	49	766.4	4.552
1.1437	1.3468	17	194.4	1.155	1.5825	1.3885	50	791.3	4.700
1.1536	1.3478	18	207.6	1.233	1.601	1.3903	51	816.5	4.849
1.1637	1.3488	19	221.1	1.313	1.619	1.3920	52	841.9	5.000
1.1739	1.3498	20	234.8	1.395	1.638	1.3937	53	868.1	5.156
1.1843	1.3508	21	248.7	1.477	1.658	1.3955	54	893.3	5.317
1.1948	1.3518	22	262.9	1.561	1.6778	1.3973	55	922.8	5.481
1.2055	1.3529	23	277.3	1.647	1.699	1.3992	56	951.4	5.651
1.2164	1.3539	24	291.9	1.734	1.720	1.4012	57	980.4	5.823
1.2275	1.3550	25	306.9	1.823	1.741	1.4032	58	1009.8	5.998
1.2387	1.3561	26	322.1	1.913	1.763	1.4052	59	1040.2	6.178
1.2502	1.3572	27	337.6	2.005	1.7846	1.4072	60	1070.8	6.360
1.2619	1.3584	28	353.3	2.098	1.808	1.4093	61	1102.9	6.550
1.2738	1.3596	29	369.4	2.194	1.831	1.4115	62	1135.8	6.746
1.2858	1.3607	30	385.7	2.291	1.856	1.4137	63	1167.3	6.945
1.298	1.3619	31	402.4	2.390	1.880	1.4160	64	1203.2	7.146
1.311	1.3631	32	419.5	2.492	1.9052	1.4183	65	1238.4	7.355
1.324	1.3644	33	436.9	2.595					

* Computed from the relationship $p^{25} = 10.2402 \eta_D^{25} - 12.6483$ for densities between 1.00 and 1.37, and $p^{25} = 10.8601 \eta_D^{25} - 13.4974$ for densities above 1.37 (Bruner and Vinograd, 1965).

[†] Divide by 10.0 to obtain % w/v.

Density data are from International Critical Tables.

Table D-3. Density, Refractive Index, and Concentration Data—Sucrose at 20°C, Molecular Weight = 342.3

Density (g/cm ³)	Refractive Index, η_D	% by Weight	mg/mL of Solution*	Molarity	Density (g/cm ³)	Refractive Index, η_D	% by Weight	mg/mL of Solution*	Molarity
0.9982	1.3330	0			1.1463	1.3883	34	389.7	1.138
1.0021	1.3344	1	10.0	0.029	1.1513	1.3902	35	403.0	1.177
1.0060	1.3359	2	20.1	0.059	1.1562	1.3920	36	416.2	1.216
1.0099	1.3374	3	30.3	0.089	1.1612	1.3939	37	429.6	1.255
1.0139	1.3388	4	40.6	0.119	1.1663	1.3958	38	443.2	1.295
1.0179	1.3403	5	50.9	0.149	1.1713	1.3978	39	456.8	1.334
1.0219	1.3418	6	61.3	0.179	1.1764	1.3997	40	470.6	1.375
1.0259	1.3433	7	71.8	0.210	1.1816	1.4016	41	484.5	1.415
1.0299	1.3448	8	82.4	0.211	1.1868	1.4036	42	498.5	1.456
1.0340	1.3464	9	93.1	0.272	1.1920	1.4056	43	512.6	1.498
1.0381	1.3479	10	103.8	0.303	1.1972	1.4076	44	526.8	1.539
1.0423	1.3494	11	114.7	0.335	1.2025	1.4096	45	541.1	1.581
1.0465	1.3510	12	125.6	0.367	1.2079	1.4117	46	555.6	1.623
1.0507	1.3526	13	136.6	0.399	1.2132	1.4137	47	570.2	1.666
1.0549	1.3541	14	147.7	0.431	1.2186	1.4158	48	584.9	1.709
1.0592	1.3557	15	158.9	0.464	1.2241	1.4179	49	599.8	1.752
1.0635	1.3573	16	170.2	0.497	1.2296	1.4200	50	614.8	1.796
1.0678	1.3590	17	181.5	0.530	1.2351	1.4221	51	629.9	1.840
1.0721	1.3606	18	193.0	0.564	1.2406	1.4242	52	645.1	1.885
1.0765	1.3622	19	204.5	0.597	1.2462	1.4264	53	660.5	1.930
1.0810	1.3639	20	216.2	0.632	1.2519	1.4285	54	676.0	1.975
1.0854	1.3655	21	227.9	0.666	1.2575	1.5307	55	691.6	2.020
1.0899	1.3672	22	239.8	0.701	1.2632	1.4329	56	707.4	2.067
1.0944	1.3689	23	251.7	0.735	1.2690	1.4351	57	723.3	2.113
1.0990	1.3706	24	263.8	0.771	1.2748	1.4373	58	739.4	2.160
1.1036	1.3723	25	275.9	0.806	1.2806	1.4396	59	755.6	2.207
1.1082	1.3740	26	288.1	0.842	1.2865	1.4418	60	771.9	2.255
1.1128	1.3758	27	300.5	0.878	1.2924	1.4441	62	788.3	2.303
1.1175	1.3775	28	312.9	0.914	1.2983	1.4464	62	804.9	2.351
1.1222	1.3793	29	325.4	0.951	1.3043	1.4486	63	821.7	2.401
1.1270	1.3811	30	338.1	0.988	1.3103	1.4509	64	838.6	2.450
1.1318	1.3829	31	350.9	1.025	1.3163	1.4532	65	855.6	2.500
1.1366	1.3847	32	363.7	1.063	1.3224	1.4558	66	872.8	2.550
1.1415	1.3865	33	376.7	1.100	1.3286	1.4581	67	890.2	2.864

*Divide by 10.0 to obtain % w/v.

Density and refractive index data are from the International Critical Tables.

Table D-4. Density Conversion for Cesium and Rubidium Salts at 20°C

% w/w	CsCl	CsBr	CsI	Cs ₂ SO ₄	CsNO ₃	RbCl	RbBr	RbI	Rb ₂ SO ₄	RbNO ₃
1	1.00593	1.00612	1.00608	1.0061	1.00566	1.00561	1.00593	1.00591	1.0066	1.0053
2	1.01374	1.01412	1.01402	1.0144	1.01319	1.01307	1.01372	1.01370	1.0150	1.0125
4	1.02969	1.03048	1.03029	1.0316	1.02859	1.02825	1.02965	1.02963	1.0322	1.0272
6	1.04609	1.04734	1.04707	1.0494	1.04443	1.04379	1.04604	1.04604	1.0499	1.0422
8	1.06297	1.06472	1.06438	1.0676	1.06072	1.05917	1.06291	1.06296	1.0680	1.0575
10	1.08036	1.08265	1.08225	1.0870	1.07745	1.07604	1.08028	1.08041	1.0864	1.0731
12	1.09828	1.10116	1.10071	1.1071	1.09463	1.09281	1.09817	1.09842	1.1052	1.0892
14	1.11676	1.12029	1.11979	1.1275	1.11227	1.11004	1.11661	1.11701	1.1246	1.1057
16	1.13582	1.14007	1.13953	1.1484		1.12775	1.13563	1.13621	1.1446	1.1227
18	1.15549	1.16053	1.15996	1.1696		1.14596	1.15526	1.15605	1.1652	1.1401
20	1.17580	1.18107	1.18112	1.1913		1.16469	1.17554	1.17657	1.1864	1.1580
22	1.19679	1.20362	1.20305	1.2137		1.18396	1.19650	1.19781	1.2083	1.1763
24	1.21849	1.22634	1.22580	1.2375		1.20379	1.21817	1.21980	1.2309	1.1952
26	1.24093	1.24990	1.24942	1.2643		1.22421	1.24059	1.24257	1.2542	1.2146
28	1.26414	1.27435	1.27395			1.24524	1.26380	1.26616	1.2782	1.2346
30	1.28817	1.29973	1.29944			1.26691	1.28784	1.29061	1.3028	1.2552
35	1.35218	1.36764	1.36776			1.32407	1.35191	1.35598	1.3281	1.2764
40	1.42245	1.44275	1.44354			1.38599	1.42233	1.42806		
45	1.49993	1.52626	1.52803			1.45330	1.50010	1.50792		
50	1.58575	1.61970	1.62278			1.52675	1.58639	1.59691		
55	1.68137	1.72492					1.68254	1.69667		
60	1.78859							1.80924		
65	1.90966							1.93722		

Glossary of Terms

angular velocity, ω	rate of rotation, measured in radians per second $\omega = \frac{2\pi \text{rpm}}{60}$ or $\omega = 0.10472 \text{ rpm}$
anodized coating	a thin, hard layer of aluminum oxide formed electrochemically on aluminum rotor and/or accessory surfaces as a protective coating for corrosion resistance
autoclaving	sterilization by heat (dry or steam)
buoyant density	the density of a particle in a specified liquid medium
Buna N	black nitrile rubber used for O-rings and gaskets in rotor assemblies; should be used at temperatures between -34 and 121°C (-30 and 250°F)
centrifugal effect	accumulated value of: $\int_{t_1}^{t_2} \omega^2 dt$ where t is time and ω is angular velocity
centrifugal force	in a centrifugal field, the force which causes a particle to move away from the center of rotation

clearing factor, k calculated for all Beckman Coulter ultracentrifuge rotors as a measure of the rotor's relative pelleting efficiency:

$$k = \frac{\ln(r_{\max}/r_{\min})}{\omega^2} \times \frac{10^{13}}{3600}$$

or

$$k = \frac{253303 \times \ln(r_{\max}/r_{\min})}{(\text{RPM} / 1000)^2}$$

clearing time, t $t = k/s$, where t is time in hours, k is the clearing factor of the rotor, and s is the sedimentation coefficient in Svedberg units (S)

CsCl cesium chloride; a high-density salt used in solution in isopycnic separations to separate particles based on their density

Cs₂SO₄ cesium sulfate; a salt, similar to CsCl, that will form its own gradient in solution

Delrin thermoplastic material (acetal homopolymer) used for most tube adapters (Delrin is a registered trademark of E.I. Du Pont de Nemours & Company.)

density mass per unit volume

density separation a centrifugal separation process based on differences in particle densities

differential separation a centrifugal separation process based on differences in particle sizes

EPDM ethylene propylene rubber used for O-rings and pad adapters; should be used at temperatures between -57 and 120°C (-70 and 250°F)

ethidium bromide a fluorescent intercalating orange dye used commonly in the separation of DNA and in gel electrophoresis

fixed angle rotor a rotor in which the tubes are held at an angle (usually 20 to 45 degrees) from the axis of rotation

g -Max™ a system of centrifugation using a combination of short Quick-Seal® tubes and floating spacers, designed to reduce volumes while maximizing separation efficiency

HDPE high density polyethylene used for adapters

isopycnic	a method of particle separation or isolation based on particle buoyant density; particles are centrifuged until they reach a point in the gradient where the density of the particle is the same as the density of the gradient at that point
konical™ tubes	thin-walled, polyallomer tubes featuring a conical tip to optimize pelleting separations; the conical tip concentrates the pellet in the narrow base of the tube. Available in both open-top and Quick-Seal bell-top designs.
maximum volume	the maximum volume at which a tube should be filled for centrifugation (sometimes referred to as maximum fill volume or nominal fill volume)
mechanical overspeed cartridge	an assembly installed in the bases of some older rotors or swinging bucket rotor adapters as part of the mechanical overspeed protection system
meniscus	the curved upper surface of a liquid column that is concave when the container walls are wetted by the liquid and convex when they are not
near vertical tube rotor	a rotor in which the tubes are held at a slight angle (usually 7 to 10 degrees)
neoprene	black synthetic elastomer used for O-rings in some tube caps and bottle cap assemblies; should be used at temperatures between -54 and 121°C (-65 and 250°F)
Noryl	modified thermoplastic polyphenylene oxide (PPO) used for floating spacers (part of the <i>g</i> -Max system) and some polycarbonate bottle caps (Noryl is a registered trademark of GE Plastics.)
OptiSeal™ tubes	capless tubes with sealing plugs inserted in the tube stems; during centrifugation, the combination of <i>g</i> force and hydrostatic pressure seals the tube
overspeed disk	an adhesive disk, with alternating reflecting and nonreflecting sectors, attached to the bottom of rotors as part of the photoelectric overspeed protection system; the number of sectors on the disk is a function of the rotor's maximum allowable speed
pelleting	a centrifugal separation process in which particles in a sample sediment to the bottom of the tube (differential separation); differential pelleting separates particles of different sizes by successive centrifugation steps of progressively higher <i>g</i> force and/or longer run duration
PET	polyethylene terephthalate used in some adapters
polyallomer	random block copolymer of ethylene and propylene used for certain tubes (Tenite Polyallomer is a registered trademark of Eastman Chemical Co.)

Quick-Seal® tubes	bell-top or dome-top thinwall tubes that are heat-sealed and require no caps
Radel	polyphenylsulfone used in plugs, cap closures, cannisters, and other accessories (Radel is a registered trademark of BP Amoco.)
rate zonal	a method of particle separation, based on differential rate of sedimentation, using a preformed gradient with the sample layered as a zone on top of the gradient
RCF	relative centrifugal field; the ratio of the centrifugal acceleration at a specified radius and speed ($r\omega^2$) to the standard acceleration of gravity (g) according to the following equation: $\text{RCF} = \frac{r\omega^2}{g}$ where r is the radius in millimeters, ω is the angular velocity in radians per second ($2\pi\text{RPM}/60$), and g is the standard acceleration of gravity (9807 mm/s^2). Thus the relationship between RCF and RPM is: $\text{RCF} = 1.12r \left(\frac{\text{RPM}}{1000} \right)^2$
r_{max}	(maximum radius) the position of the liquid in the tube at the maximum distance from the axis of rotation when the rotor is at speed
r_{min}	(minimum radius) the position of the liquid in the tube at the minimum distance from the axis of rotation when the rotor is at speed
sedimentation	the settling out of particles from a suspension in the earth's field of gravity; in the centrifuge this process is accelerated and the particles move away from the axis of rotation
sedimentation coefficient, s	sedimentation velocity per unit of centrifugal force: $s = \frac{dr}{dt} \times \frac{1}{\omega^2 r}$
silicone rubber	a large group of silicone elastomers used in various accessories; should be used at temperatures between -59 and 232°C (-75 and 450°F)
Solution 555™	Beckman Coulter concentrated rotor cleaning solution; recommended because it is a mild solution that has been tested and found effective and safe for Beckman Coulter rotors and accessories

Spinkote™	Beckman Coulter lubricant for metal-to-metal contacts
sucrose	a sugar (not a self-forming gradient) used in rate zonal separations; generally used in separating RNA, subcellular organelles, and cell membranes
supernatant	the liquid above the sedimented material following centrifugation
Svedberg unit, <i>S</i>	a unit of sedimentation velocity: $1 S = 10^{-13}$ seconds
swinging bucket rotor	a rotor in which the tubes or bottles are carried in buckets that swing up to the horizontal position during centrifugation (sometimes referred to as a horizontal or swing-out rotor)
Ultem	polyetherimide (PEI)—used in adapters, covers, and spacers; should be used at temperatures between -29 and 204°C (-20 and 400°F) (Ultem is a registered trademark of GE Plastics.)
vertical tube rotor	a rotor in which the tubes or bottles are held parallel to the axis of rotation
Viton	fluorocarbon elastomer used in high-temperature applications (Viton is a registered trademark of E.I. Du Pont de Nemours & Company.)
wettable	tube or bottle material that water or other aqueous solution will adhere to; the more wettable a tube or bottle material is, the more biological material, DNA, protein, cells, and so forth, will adhere to the walls

Appendix F

References

Documents referenced below are available upon request from:*

Beckman Coulter, Inc.
Technical Publications
1050 Page Mill Road
Palo Alto, CA 94304 U.S.A.

- IN-181 *How to Use Quick Seal® Tubes with the Beckman Coulter Cordless Tube Topper™*
- IN-189 *Using OptiSeal™ Tubes*
- IN-192 *Use and Care of Centrifuge Tubes and Bottles*
- IN-197 *Rotor Safety (Multi-lingual)*
- L-ML *Master Logbook for Ultracentrifuge Rotors*
- L5-TB-006 *Instructions for Using the Tube-Cap Vise*
- L5-TB-010 *Instructions for Using the Beckman Tube Slicer*
- L5-TB-060 *Instructions for Using Aluminum Tube Caps in Fixed Angle Ultracentrifuge Rotors*
- L5-TB-072 *Run Speeds for Stainless Steel Tubes*
- L5-TB-081 *Beckman Fraction Recovery Systems*

* For detailed information on a rotor, see the applicable individual rotor manual.

Documents referenced below are available at www.beckmancoulter.com or upon request from:

Beckman Coulter, Inc.
Marketing Communications
4300 N. Harbor Blvd., Box 3100
Fullerton, CA 92834 U.S.A.

- A-1824 *Plasmid Isolation Using NVT™ Near Vertical Tube Rotor*
- A-1846 *Selected Run Conditions for Optimizing the Separation of RNA Using Centrifugation in Either a Preparative Floor or Tabletop Instrument*
- A-1938 *Prediction of Bovine Serum Albumin Pelleting Using the ESP Pelleting Simulation from the Optima™ eXPert Software*
- A-1941 *Predicting Protein Separation in Rate Zonal Centrifugation Using the E Run simulation from the Optima™ eXPert Software*
- A-2038 *Preparation of Intestinal Mucins Using the NVT-65 Near Vertical Tube Rotor*
- AR-8093 *Fast Separations of Plasmid DNA Using Discontinuous Gradients in the Preparative Ultracentrifuge*
- BA99-60495 *Rotor Safety Guide — Warranty and Care*
- BR-8101 *Ultracentrifuge Rotors, Tubes & Accessories Catalog*
- BR-9272 *Optima™ L-XP*
- DS-468 *Techniques of Preparative, Zonal, and Continuous Flow Ultracentrifugation*
- DS-514 *Ultracentrifuge Methods for Lipoprotein Research*
- DS-528 *Use of the ω^2t Integrator*
- DS-694 *30-Minute 2-Step Purification of Plasma Membranes from Cultured Cells*
- DS-709 *g-Max System: Short Pathlengths in High Force Fields*
- DS-728 *Optimizing Centrifugal Separations: Sample Loading*

- DS-770 *Plasmid Separations in NVT Near Vertical Tube Rotors*
- DS-793 *Preparation of Intestinal Mucins Using the NVT 65 Near Vertical Tube Rotor*
- DS-887 *Obtain Greater Purity and Efficiency with the New NVT 65.2 Rotor*
- DS-9271 *Using k Factor to Compare Rotor Efficiency*
- DS-9338 *Optima™ L-80 XP Ultracentrifuge Datasheet*
- DS-9339 *Optima™ L-90K Ultracentrifuge Datasheet*
- DS-9340 *Optima™ L-100 XP Ultracentrifuge Datasheet*
- DS-9343 *OptiSeal™ Ultracentrifuge Tubes*
- SR-171 *Rapid Isolation of Both RNA & DNA from Cultured Cell*
- SR-182 *Purity, Antigenicity, and Immunogenicity*

ULTRACENTRIFUGE ROTOR WARRANTY

All Beckman Coulter ultracentrifuge Fixed Angle, Vertical Tube, Near Vertical Tube, Swinging Bucket, and Airfuge rotors are warranted against defects in materials or workmanship for the time periods indicated below, subject to the Warranty Conditions stated below.

Preparative Ultracentrifuge Rotors 5 years — No Proration

Analytical Ultracentrifuge Rotors 5 years — No Proration

ML and TL Series Ultracentrifuge Rotors 5 years — No Proration

Airfuge Ultracentrifuge Rotors 1 year — No Proration

For Zonal, Continuous Flow, Component Test, and Rock Core ultracentrifuge rotors, see separate warranty.

Warranty Conditions (as applicable)

- 1) This warranty is valid for the time periods indicated above from the date of shipment to the original Buyer by Beckman Coulter or an authorized Beckman Coulter representative.
- 2) This warranty extends only to the original Buyer and may not be assigned or extended to a third person without written consent of Beckman Coulter.
- 3) This warranty covers the Beckman Coulter Centrifuge Systems only (including but not limited to the centrifuge, rotor, and accessories) and Beckman Coulter shall not be liable for damage to or loss of the user's sample, non-Beckman Coulter tubes, adapters, or other rotor contents.
- 4) This warranty is void if the Beckman Coulter Centrifuge System is determined by Beckman Coulter to have been operated or maintained in a manner contrary to the instructions in the operator's manual(s) for the Beckman Coulter Centrifuge System components in use. This includes but is not limited to operator misuse, abuse, or negligence regarding indicated maintenance procedures, centrifuge and rotor classification requirements, proper speed reduction for the high density of certain fluids, tubes, and tube caps, speed reduction for precipitating gradient materials, and speed reduction for high-temperature operation.
- 5) Rotor bucket sets purchased concurrently with or subsequent to the purchase of a Swinging Bucket Rotor are warranted only for a term co-extensive with that of the rotor for which the bucket sets are purchased.
- 6) This warranty does not cover the failure of a Beckman Coulter rotor in a centrifuge not of Beckman Coulter manufacture, or if the rotor is used in a Beckman Coulter centrifuge that has been modified without the written permission of Beckman Coulter, or is used with carriers, buckets, belts, or other devices not of Beckman Coulter manufacture.
- 7) Rotor parts subject to wear, including but not limited to rotor O-rings, VTi, NVT™, TLV, MLN, and TLN rotor tube cavity plugs and gaskets, tubing, tools, optical overspeed disks, bearings, seals, and lubrication are excluded from this warranty and should be frequently inspected and replaced if they become worn or damaged.
- 8) Keeping a rotor log is not mandatory, but may be desirable for maintenance of good laboratory practices.

Repair and Replacement Policies

- 1) If a Beckman Coulter rotor is determined by Beckman Coulter to be defective, Beckman Coulter will repair or replace it, subject to the Warranty Conditions. A replacement rotor will be warranted for the time remaining on the original rotor's warranty.
- 2) If a Beckman Coulter centrifuge is damaged due to a failure of a rotor covered by this warranty, Beckman Coulter will supply free of charge (i) all centrifuge parts required for repair (except the drive unit, which will be replaced at the then current price less a credit determined by the total number of revolutions or years completed, provided that such a unit was manufactured or rebuilt by Beckman Coulter), and (ii) if the centrifuge is currently covered by a Beckman Coulter warranty or Full Service Agreement, all labor necessary for repair of the centrifuge.
- 3) If a Beckman Coulter rotor covered by this warranty is damaged due to a malfunction of a Beckman Coulter ultracentrifuge covered by an Ultracentrifuge System Service Agreement, Beckman Coulter will repair or replace the rotor free of charge.
- 4) If a Beckman Coulter rotor covered by this warranty is damaged due to a failure of a Beckman Coulter tube, bottle, tube cap, spacer, or adapter, covered under the Conditions of this Warranty, Beckman Coulter will repair or replace the rotor and repair the instrument as per the conditions in policy point (2) above, and the replacement policy.
- 5) Damage to a Beckman Coulter rotor or instrument due to the failure or malfunction of a non-Beckman Coulter tube, bottle, tube cap, spacer, or adapter is not covered under this warranty, although Beckman Coulter will assist in seeking compensation under the manufacturer's warranty.

Disclaimer

IT IS EXPRESSLY AGREED THAT THE ABOVE WARRANTY SHALL BE IN LIEU OF ALL WARRANTIES OF FITNESS AND OF THE WARRANTY OF MERCHANTABILITY AND BECKMAN COULTER SHALL HAVE NO LIABILITY FOR SPECIAL OR CONSEQUENTIAL DAMAGES OF ANY KIND WHATSOEVER ARISING OUT OF THE MANUFACTURE, USE, SALE, HANDLING, REPAIR, MAINTENANCE, OR REPLACEMENT OF THE PRODUCT.

Factory Rotor Inspection Service

Beckman Coulter, Inc., will provide free mechanical and metallurgical inspection in Palo Alto, California, USA, of any Beckman Coulter rotor at the request of the user. (Shipping charges to Beckman Coulter are the responsibility of the user.) Rotors will be inspected in the user's laboratory if the centrifuge in which they are used is covered by an appropriate Beckman Coulter Service Agreement. Contact your local Beckman Coulter office for details of service coverage or cost.

Before shipping, contact the nearest Beckman Coulter Sales and Service office and request a Returned Goods Authorization (RGA) form and packaging instructions. Please include the complete rotor assembly, with buckets, lid, handle, tube cavity caps, etc. A SIGNED STATEMENT THAT THE ROTOR AND ACCESSORIES ARE NON-RADIOACTIVE, NON-PATHOGENIC, NON-TOXIC, AND OTHERWISE SAFE TO SHIP AND HANDLE IS REQUIRED.

Beckman Coulter Worldwide Biomedical Research Division Offices

AUSTRALIA

Beckman Coulter Australia Pty Ltd
Unit D, 24 College St.
Gladesville, NSW 2111
Australia
Telephone: (61) 2 9844-6000
or toll free: 1 800 060 880
Fax: (61) 2 9844-6096
email: lifescienceaustralia@beckman.com

CANADA

Beckman Coulter (Canada) Inc.
6755 Mississauga Road, Suite 600
Mississauga, Ontario
Canada L5N 7Y2
Telephone: (905) 819-1234
Fax: (905) 819-1485

CHINA

Beckman Coulter Inc.
Beijing Representative Office
Unit 2005A, 2006-2009, East Ocean Center
Jian Guomenwai Avenue
Beijing 100004
China
Telephone: (86) 10 6515 6028
Fax: (86) 10 6515 6025, 6515 6026

EASTERN EUROPE/ MIDDLE EAST/NORTH AFRICA

Beckman Coulter International S.A.
22, Rue Juste-Olivier
Case Postale 301-303
CH-1260 Nyon, Switzerland
Telephone: (41) 22 994 07 07
Fax: (41) 22 994 07 00

FRANCE

Beckman Coulter France S.A.
Paris Nord II, 33/66 rue des Vanesses
B.P. 50359
Villepinte, France
95942 ROISSY CDG Cedex
Telephone: 01 49 90 90 00
Fax: 01 49 90 90 10
e-mail: bioresearch.france@beckman.com

GERMANY

Beckman Coulter GmbH
Europark Fichtenhain B-13
47807 Krefeld
Germany
Telephone: 49 21 513335
Fax: 49 21 51333633
e-mail: bioresearch.de@beckman.com



HONG KONG

Beckman Coulter Hong Kong Ltd.
12th Floor, Oxford House
979 King's Road
Taikoo Place, Hong Kong
Telephone: (852) 2814 7431, 2814 0481
Fax: (852) 2873 4511

ITALY

Beckman Coulter S.p.a.
Centro Direzionale Lombardo
Palazzo F/1, Via Roma 108
20060 Cassina de' Pecchi
Milano, Italy
Telephone: 02-953921
Fax: 02-95392264

JAPAN

Beckman Coulter K.K.
Toranomon 37 Mori Bldg.
3-5-1, Toranomon
Minato-ku, Tokyo 105-0001
Japan
Telephone: 03-5404-8359
Fax: 03-5404-8436

MEXICO

Beckman Coulter de Mexico S.A. DE C.V.
Avenida Popocatepetl #396
Colonia Gral. Pedro Maria Anaya
Codigo Postal 03340
Mexico, D.F. Mexico
Telephone: 525 605-77-70
Fax: 525 575-18-25

NETHERLANDS

Beckman Coulter Nederland B.V.
Nijverheidsweg 21
3641 RP-Mijdrecht
Postbus 47
3640 AA Mijdrecht
The Netherlands
Telephone: 0297-230630
Fax: 0297-288082

SINGAPORE

Beckman Coulter Singapore Pte. Ltd.
116 Changi Road
Unit #03-01/02
Singapore 419718
Telephone: (65) 6339 3633
Fax: (65) 6336 6303

SOUTH AFRICA/SUB-SAHARAN AFRICA

Beckman Coulter
Stand 1A Primegro Park
Tonetti Street
1685 Halfway House
Johannesburg
Republic of South Africa
Telephone: (27) 11-805-2014/5
Fax: (27) 11-805-4120
e-mail: beckman@intekom.co.za

SPAIN

Beckman Coulter España S.A.
C/ Caleruega, 81
28033 Madrid, Spain
Telephone: 91 3836080
Fax: 91 3836096
email: bioresearch.espana@beckman.com

SWEDEN

Beckman Coulter AB
Archimedesvaegen 7
Box 111 56
SE-168 11 Bromma
Sweden
Telephone: (0)8 564 85 900
Telefax: (0)8 564 85 901

SWITZERLAND

Beckman Coulter International S.A.
22, Rue Juste-Olivier
Case Postale 301-303
CH-1260 Nyon
Switzerland
Telephone: 0800 850 810
Fax: 0848 850 810

TAIWAN

Beckman Coulter Taiwan Inc.
Taiwan Branch
8th Floor
216 Tun Hwa South Road, Section 2
Taipei 106, Taiwan
Republic of China
Telephone: (886) 2 2378 3456
Fax: (886) 2 2377 0408

TURKEY

Beckman Coulter Ltd.
E-5 Yanyol Faith Cad.
81410 Soganklik Kartal
Istanbul
Turkey
Telephone: 90 216 309 1900
Fax: 90 216 309 0090

UNITED KINGDOM

Beckman Coulter United Kingdom Ltd
Oakley Court
Kingsmead Business Park
London Road
High Wycombe
Buckinghamshire HP11 1JU
England, U.K.
Telephone: 01494 441181
Fax: 01494 447558
e-mail: beckman_uk@beckman.com

Authorized dealers in other countries.

Beckman Coulter, Inc. • 4300 N. Harbor Boulevard, Box 3100 • Fullerton, California 92834-3100
Sales and Service: 1-800-742-2345 • Internet: www.beckmancoulter.com • Telex: 678413 • Fax: 1-800-643-4366

